

# 17

## Patient-Monitoring Systems

REED M. GARDNER AND M. MICHAEL SHABOT

After reading this chapter,<sup>1</sup> you should know the answers to these questions:

- What is patient monitoring, and why is it done?
- What are the primary applications of computerized patient-monitoring systems in the intensive-care unit?
- How do computer-based patient monitors aid health professionals in collecting, analyzing, and displaying data?
- What are the advantages of using microprocessors in bedside monitors?
- What are the important issues for collecting high-quality data either automatically or manually in the intensive-care unit?
- Why is integration of data from many sources in the hospital necessary if a computer is to assist in critical-care-management decisions?

### 17.1 What Is Patient Monitoring?

Continuous measurement of patient parameters such as heart rate and rhythm, respiratory rate, blood pressure, blood-oxygen saturation, and many other parameters have become a common feature of the care of critically ill patients. When accurate and immediate decision-making is crucial for effective patient care, electronic monitors frequently are used to collect and display physiological data. Increasingly, such data are collected using non-invasive sensors from less seriously ill patients in a hospital's medical-surgical units, labor and delivery suites, nursing homes, or patients' own homes to detect unexpected life-threatening conditions or to record routine but required data efficiently.

We usually think of a **patient monitor** as something that watches for—and warns against—serious or life-threatening events in patients, critically ill or otherwise. **Patient monitoring** can be rigorously defined as “repeated or continuous observations or measurements of the patient, his or her physiological function, and the function of life support equipment, for the purpose of guiding management decisions, including when to make therapeutic interventions, and assessment of those interventions” (Hudson, 1985, p. 630). A patient monitor may not only alert caregivers to potentially life-threatening

---

<sup>1</sup>Portions of this chapter are based on Shabot M.M., Gardner R.M. (Eds.) (1994). *Decision Support Systems in Critical Care*, Boston, Springer-Verlag; and Gardner R.M., Sittig D.F., Clemmer T.P. (1995). *Computers in the ICU: A Match Meant to Be!* In Ayers S.M., et al. (Eds.), *Textbook of Critical Care* (3rd ed., p. 1757). Philadelphia, W.B. Saunders.

events; many also provide physiologic input data used to control directly connected life-support devices.

In this chapter, we discuss the use of computers to assist caregivers in the collection, display, storage, and decision-making, including interpretation of clinical data, making therapeutic recommendations, and alarming and alerting. In the past, most clinical data were in the form of heart and respiratory rates, blood pressures, and flows, but today they include integrating data from bedside instruments which measure blood gases, chemistry, and hematology as well as integrating data from many sources outside the intensive-care unit (ICU). Although we deal primarily with patients who are in ICUs, the general principles and techniques are also applicable to other hospitalized patients. For example, patient monitoring may be performed for diagnostic purposes in the emergency room or for therapeutic purposes in the operating room. Techniques that just a few years ago were used only in the ICU are now routinely used on general hospital units and in some situations by patients at home.

### ***17.1.1 A Case Report***

We will use a case report to provide a perspective on the problems faced by the health-care team caring for a critically ill patient: A young man is injured in an automobile accident. He has multiple chest and head injuries. His condition is stabilized at the accident scene by skilled paramedics using a microcomputer-based **electrocardiogram** (ECG) monitor, and he is quickly transported to a trauma center. Once in the trauma center, the young man is connected via sensors to computer-based monitors that determine his heart rate and rhythm and his blood pressure. Because of the head injury, the patient has difficulty breathing, so he is connected to a microprocessor-controlled ventilator. Later, he is transferred to the ICU. A fiberoptic pressure-monitoring sensor is inserted through a bolt drilled through his skull to continuously measure intracranial pressure with another computer-controlled monitor. Clinical chemistry and blood-gas tests are performed in two minutes at the bedside with a microcartridge inserted into the physiologic monitor, and the results are transmitted to the laboratory computer system and the ICU system using a Health Level 7 (HL7) interface over a standard Ethernet network. With intensive treatment, the patient survives the initial threats to his life and now begins the long recovery process.

Unfortunately, a few days later, he is beset with a problem common to multiple trauma victims—he has a major *nosocomial* (hospital-acquired) *infection* and develops **sepsis**, **adult respiratory distress syndrome** (ARDS), and multiple organ failure. As a result, even more monitoring sensors are needed to acquire data and to assist with the patient's treatment; the quantity of information required to care for the patient has increased dramatically.

The ICU computer system provides suggestions about how to care for the specific problems, provides visual alerts for life-threatening situations, and organizes and reports the mass of data so that caregivers can make prompt and reliable treatment decisions. The patient's physicians are automatically alerted to critical laboratory and blood gas results as well as to complex physiological conditions by detailed alphanumeric pager messages. His ARDS is managed with the assistance of a computer-monitored

and controlled protocol. Figure 17.1 shows a nurse at the patient's bedside surrounded by a **bedside monitor**, **infusion pumps** and a **microprocessor controlled ventilator**. Figure 17.2 shows an example of a computer-generated ICU report produced by the HELP system (HELP is discussed in Chapter 13). This report summarizes 24 hours of patient data and is used by physicians to review a patient's status during daily rounds (daily visits by physicians to their hospitalized patients).

### ***17.1.2 Patient Monitoring in Intensive-Care Units***

There are at least five categories of patients who need physiological monitoring:

1. Patients with unstable physiological regulatory systems; for example, a patient whose respiratory system is suppressed by a drug overdose or anesthesia
2. Patients with a suspected life-threatening condition; for example, a patient who has findings indicating an acute myocardial infarction (heart attack)
3. Patients at high risk of developing a life-threatening condition; for example, patients immediately after open-heart surgery or a premature infant whose heart and lungs are not fully developed
4. Patients in a critical physiological state; for example, patients with multiple trauma or septic shock.
5. Mother and baby during the labor and delivery process.



**Figure 17.1.** A nurse at a patient's ICU bedside. Above the nurse's head is the bedside monitor which measure and displays key physiological data, above her left hand is an IV pump connected to a Medical Information Bus (MIB), to her right are two screens of a patient ventilator and to the far right is a bedside computer terminal used for data entry and data review. (*Source:* Courtesy of Dr. Reed M. Gardner)

LDS HOSPITAL ICU ROUNDS REPORT  
DATA WITHIN LAST 24 HOURS

NAME: STEVEN NO. 10072 ROOM: E609 DATE: JAN 29 14:17  
 DR. STINSON, JAMES B. SEX: M AGE: 43 HEIGHT: 178 WEIGHT: 75.40 BSA: 1.93 BEE: 1697 MOP: 0  
 ADMT DIAGNOSIS: FEVER UNK ORIGM, S/P KIDNEY TR ADMIT DATE: 14 DEC 88

---

CARDIOVASCULAR: 0 EXAM: \_\_\_\_\_  
 -- NO CARDIAC OUTPUT DATA AVAILABLE

	SP	DP	MP	HR	LACT	CPK	CPK-MB	LDH-1	LDH-2
LAST VALUES	121	68	89	113	( )	( )	( )	( )	( )
MAXIMUM	194	97	126	124					
MINIMUM	101	58	72	83					

---

RESPIRATORY: 0

	pH	PCO2	HCO3	BE	HB	CO/MT	P02	S02	O2CT	%O2	AVO2	VO2	C.O.	A-a	QS/QT	PK/	PL/PP	MR/SR
29 06:21 A	7.43	27.3	18.0	-4.5	10.0	2/1	80	94	13.2	30				66		0/	0/	5/17/0

SAMPLE # 74, TEMP 38.4, BREATHING STATUS : ASSIST/CONTROL  
 NORMAL ARTERIAL ACID-BASE CHEMISTRY  
 SEVERELY REDUCED O2 CONTENT (13.2) DUE TO ANEMIA (LOW HB)

machine settings										patient values												
VENT	MODE	VR	Vt	O2%	PF	IP	MAP	PK	PL	PP	m-Vt	c-Vt	s-Vt	MR	SR	TR	m-VE	s-VE	t-VE	Clh	Pc	
29 14:15	B-I	A/C	16	700	30	50		32	26	5	866	731	29				21.2					34.8
29 06:05	B-I	A/C	16	700	30	50		22	20	5	830	745	19				14.2					49.7

29 14:15 5/14:16 INTERFACE: TRACH TUBE; ALARMS CHECKED; POSITION: SUPINE; THERAPIST: DAVIS, TERIANNE, CRTT  
 29 06:05 10/06:08 INTERFACE: TRACH TUBE; ALARMS CHECKED; POSITION: SEMI-FOWLER; PATIENT CONDITION: CALM; SUCTIONED, 3 CC, HEMOPTIC; THERAPIST: TARR, TED, RRT

---

DATE TIME HR VR VT VC VE MIP MEP MVV PK FLOW THERAPIST EXAM: \_\_\_\_\_  
 01/29/89 07:15 109 20 600 12.0 -60 DAVIS, TERIANNE

---

NEURO AND PSYCH: 0  
 GLASCOW 6 (08:00) VERBAL \_\_\_\_\_ EYELIDS \_\_\_\_\_ MOTOR \_\_\_\_\_ PUPILS \_\_\_\_\_ SENSORY \_\_\_\_\_  
 DTR \_\_\_\_\_ BABIN. \_\_\_\_\_ ICP \_\_\_\_\_ PSYCH \_\_\_\_\_

---

COAGULATION: 0  
 PT: 14.2 (05:15 ) PTT: 50 (05:15 ) PLATELETS: 89 (05:15 ) FIBRINOGEN: 0(00:00) EXAM: \_\_\_\_\_  
 FSP-CON: 0 (00:00) FSP-PT: 0 (00:00) 3P: (00:00)

---

RENAL, FLUIDS, LYTES: 0

IN	3430	CRYST	1025	COLLOID	1035	BLOOD	NG/PO	1340	NA	( )	K	( )	CL	( )
OUT	2689	URINE	800	NGOUT	500	DRAINS	25 OTHER	1364	CO2	21.0 (05:15)	BUN	51 (05:15)	CRE	4.2 (05:15)
NET	741	WT	75.40	WT-CHG	S.G.	1.015			AGAP	16.7	UOSM		UNA	CRCL

---

METABOLIC --- NUTRITION: 0

KCAL/N2	891	UUN	.0 (00:00)	N-BAL	.0	CA	7.7 (05:15)	FE	.0 (00:00)	TIBC	0 (00:00)
						P04	1.9 (05:15) <td>MG</td> <td>1.9 (05:15) <td>CHOL</td> <td>228 (05:15) </td></td>	MG	1.9 (05:15) <td>CHOL</td> <td>228 (05:15) </td>	CHOL	228 (05:15)

---

GI, LIVER, AND PANCREAS: 0 EXAM: \_\_\_\_\_  
 HCT 29.4 (05:15) TOTAL BILLI 23.1 (05:15) SGOT 73 (05:15) ALKP04 957 (05:15) GGT 768 (05:15)  
 GUA1AC ( ) DIRECT BILLI 17.4 (05:15) SGPT 99 (05:15) LDH 237 (05:15) AMYLASE 0 (00:00)

---

INFECTION: 0  
 WBC 5.2(05:15 ) TEMP 40.3 (28/06:00) DIFF 26 B, 70P, 3L, 1M, E (05:15) GRAM STAIN: SPUTUM \_\_\_\_\_ OTHER \_\_\_\_\_

---

SKIN AND EXTREMITIES:  
 PULSES \_\_\_\_\_ RASH \_\_\_\_\_ DECUBITI \_\_\_\_\_

---

TUBES:  
 VEN \_\_\_\_\_ ART \_\_\_\_\_ SG \_\_\_\_\_ NG \_\_\_\_\_ FOLEY \_\_\_\_\_ ET \_\_\_\_\_ TRACH \_\_\_\_\_ DRAIN \_\_\_\_\_  
 CHEST \_\_\_\_\_ RECTAL \_\_\_\_\_ JEJUNAL \_\_\_\_\_ DIALYSIS \_\_\_\_\_ OTHER \_\_\_\_\_

---

MEDICATIONS:

MORPHINE, INJ	MGM	IV	20	AMPHOJEL, LIQUID	ML	NG	30
MEPERIDINE (DEMEROL), INJ	MGM	IV	150	DIPHENHYDRAMINE (BENADRYL), INJ	MGM	IV	100
PHENYTOIN (DILANTIN), SUSPENSION	MGM	NG	300	HYDROCORTISONE NA SUCCINATE (SOLU-CORTEF)MGM,	IV		200
MIDAZOLAM (VERSED), INJ	MGM	IV	5	AMIN-AID FULL STRENGTH, LIQUID	ML	NG D	1380
AMPHOTERICIN B, INJ	MGM	IV	40	TAP WATER, LIQUID	ML	NG	60
CEFTAZIDIME (FORTAZ), INJ	MGM	IV	1000	MAGNESIUM SULFATE 50%, INJ	GM	IV	2
SUCRALFATE (CARAFATE), TAB	MGM	NG	4000	POTASSIUM CHLORIDE, INJ	MEQ	IV	20
FAMOTIDINE (PEPCID), INJ	MGM	IV	40	NOVOLIN REGULAR, INJ	UNITS	IV	58

#087 - 021

Figure 17.2. Rounds report used at LDS Hospital in Salt Lake City for evaluation of patients each day during teaching and decision-making rounds. The report abstracts data from diverse locations and sources and organizes them to reflect the physiological systems of interest. Listed at the top of the report is patient-identification and patient-characterization information. Next is information about the cardiovascular system; data for other systems follow. (Source: Courtesy of LDS Hospital.)

Care of the critically ill patient requires prompt and accurate decisions so that life-protecting and life-saving therapy can be appropriately applied. Because of these requirements, ICUs have become widely established in hospitals. Such units use computers almost universally for the following purposes:

- To acquire physiological data frequently or continuously, such as blood pressure readings
- To communicate information from data-producing systems to remote locations (e.g., laboratory and radiology departments)
- To store, organize, and report data
- To integrate and correlate data from multiple sources
- To provide clinical alerts and advisories based on multiple sources of data
- To function as a decision-making tool that health professionals may use in planning the care of critically ill patients
- To measure the severity of illness for patient classification purposes
- To analyze the outcomes of ICU care in terms of clinical effectiveness and cost effectiveness

## 17.2 Historical Perspective

The earliest foundations for acquiring physiological data date to the end of the Renaissance period.<sup>2</sup> In 1625, Santorio, who lived in Venice at the time, published his methods for measuring body temperature with the spirit thermometer and for timing the pulse (heart) rate with a pendulum. The principles for both devices had been established by Galileo, a close friend. Galileo worked out the uniform periodicity of the pendulum by timing the period of the swinging chandelier in the Cathedral of Pisa, using his own pulse rate as a timer. The results of this early biomedical-engineering collaboration, however, were ignored. The first scientific report of the pulse rate did not appear until Sir John Floyer published “Pulse-Watch” in 1707. The first published course of fever for a patient was plotted by Ludwig Taube in 1852. With subsequent improvements in the clock and the thermometer, the temperature, pulse rate, and respiratory rate became the standard **vital signs**.

In 1896, Scipione Riva-Rocci introduced the sphygmomanometer (blood pressure cuff), which permitted the fourth vital sign, arterial blood pressure, to be measured. A Russian physician, Nikolai Korotkoff, applied Riva-Rocci’s cuff with a stethoscope developed by the French physician Rene Laennec to allow the auscultatory measurement<sup>3</sup> of both systolic and diastolic arterial pressure. Harvey Cushing, a preeminent U.S. neurosurgeon of the early 1900s, predicted the need for and later insisted on routine arterial blood pressure monitoring in the operating room. Cushing also raised two questions familiar even at the turn of the century: (1) Are we collecting too much data?

---

<sup>2</sup>This section has been adapted, with permission, from Glaeser D.H., Thomas L.J. Jr. (1975). Computer monitoring in patient care. *Annual Review of Biophysics and Bioengineering*, 4:449–476, copyright Annual Reviews, Inc.

<sup>3</sup>In medicine, auscultation is the process of listening to the sounds made by structures within the body, such as by the heart or by the blood moving within the vessels.

(2) Are the instruments used in clinical medicine too accurate? Would not approximated values be just as good? Cushing answered his own questions by stating that vital-sign measurements should be made routinely and that accuracy was important (Cushing, 1903).

Since the 1920s, the four vital signs—temperature, respiratory rate, heart rate, and arterial blood pressures—have been recorded in all patient charts. In 1903, Willem Einthoven devised the string galvanometer for measuring the electrocardiogram (ECG), for which he was awarded the 1924 Nobel Prize in physiology. The ECG has become an important adjunct to the clinician's inventory of tests for both acutely and chronically ill patients. Continuous measurement of physiological variables has become a routine part of the monitoring of critically ill patients.

At the same time that advances in monitoring were made, major changes in the therapy of life-threatening disorders were also occurring. Prompt quantitative evaluation of measured physiological and biochemical variables became essential in the decision-making process as physicians applied new therapeutic interventions. For example, it is now possible—and in many cases essential—to use ventilators when a patient cannot breathe independently, cardiopulmonary bypass equipment when a patient undergoes open-heart surgery, hemodialysis when a patient's kidneys fail, and intravenous (IV) nutritional and electrolyte (e.g., potassium and sodium) support when a patient is unable to eat or drink.

### ***17.2.1 Development of Intensive-Care Units***

To meet the increasing demands for more acute and intensive care required by patients with complex disorders, new organizational units—the ICUs—were established in hospitals beginning in the 1950s. The earliest units were simply postoperative recovery rooms used for prolonged stays after open-heart surgery. Intensive-care units proliferated rapidly during the late 1960s and 1970s. The types of units include burn, coronary, general surgery, open-heart surgery, pediatric, neonatal, respiratory, and multipurpose medical-surgical units. Today there are an estimated 75,000 adult, pediatric, and neonatal intensive care beds in the United States.

The development of **transducers** and electronic instrumentation during World War II dramatically increased the number of physiological variables that could be monitored. Analog-computer technology was widely available, as were oscilloscopes, electronic devices used to depict changes in electrical potential on a cathode-ray tube (CRT) screen. These devices were soon used in specialized cardiac-catheterization<sup>4</sup> laboratories, and they rapidly found their way to the bedside.

Treatment for serious cardiac arrhythmias (rhythm disturbances) and cardiac arrest (abrupt cessation of heartbeat)—major causes of death after myocardial infarctions—became possible. As a result, there was a need to monitor the ECGs of patients who had suffered heart attacks so that these episodes could be noticed and

---

<sup>4</sup>A procedure whereby a tube (catheter) is passed into the heart through an artery or vein, allowing the cardiologist to measure pressure within the heart's chambers, to obtain blood samples, to inject contrast dye for radiological procedures, and so

treated immediately. In 1963, Day reported that treatment of postmyocardial-infarction patients in a coronary-care unit reduced mortality by 60 percent. As a consequence, coronary-care units—with ECG monitors—proliferated. The addition of online blood-pressure monitoring quickly followed. **Pressure transducers**, already used in the cardiac-catheterization laboratory, were easily adapted to the monitors in the ICU.

With the advent of more automated instruments, the ICU nurse could spend less time manually measuring the traditional vital signs and more time observing and caring for the critically ill patient. Simultaneously, a new trend emerged; some nurses moved away from the bedside to a central console where they could monitor the ECG and other vital-sign reports from many patients. Maloney (1968) pointed out that this was an inappropriate use of technology when it deprived the patient of adequate personal attention at the bedside. He also suggested that having the nurse record vital signs every few hours was “only to assure regular nurse–patient contact” (Maloney, 1968, p. 606).

As monitoring capabilities expanded, physicians and nurses soon were confronted with a bewildering number of instruments; they were threatened by **data overload**. Several investigators suggested that the digital computer might be helpful in solving the problems associated with data collection, review, and reporting.

### ***17.2.2 Development of Computer-Based Monitoring***

Teams from several cities in the United States introduced computers for physiological monitoring into the ICU, beginning with Shubin and Weil (1966) in Los Angeles and then Warner and colleagues (1968) in Salt Lake City. These investigators had several motives: (1) to increase the availability and accuracy of data, (2) to compute derived variables that could not be measured directly, (3) to increase patient-care efficacy, (4) to allow display of the time trend of patient data, and (5) to assist in computer-aided decision-making. Each of these teams developed its application on a mainframe computer system, which required a large computer room and special staff to keep the system operational 24 hours per day. The computers used by these developers cost over \$200,000 each in 1965 dollars! Other researchers were attacking more specific challenges in patient monitoring. For example, Cox and associates (1972) in St. Louis developed algorithms to analyze the ECG for heart rhythm disturbances in real-time. The arrhythmia-monitoring system, which was installed in the coronary-care unit of Barnes Hospital in 1969, ran on a relatively inexpensive microcomputer.

As we described in Chapter 5, the advent of integrated circuits and other advances allowed computing power per dollar to increase dramatically. As hardware became smaller, more reliable, and less expensive, and as better software tools were developed, simple analog processing gave way to digital signal processing. Monitoring applications developed by the pioneers using large central computers now became possible using dedicated microprocessor-based machines at the bedside.

The early bedside monitors were built around “bouncing-ball” or conventional oscilloscopes and analog-computer technology. As computer technology has advanced, the definition of **computer-based monitoring** has changed. The early developers spent a major part of their time deriving data from analog physiological signals. Soon the

data-storage and decision-making capabilities of the computer monitoring systems came under the investigator's scrutiny. Therefore, what was considered computer-based patient monitoring in the late 1960s and early 1970s is now entirely built into bedside monitors and is considered simply a "bedside monitor." Systems with database functions, report-generation systems, and some decision-making capabilities are usually called **computer-based patient monitors**.

### 17.3 Data Acquisition and Signal Processing

The use of microcomputers in bedside monitors has revolutionized the acquisition, display, and processing of physiological data. There are virtually no bedside monitors or ventilators marketed today that do not use at least one microcomputer. Figure 17.3 shows a block diagram of a bedside monitor. Physiological signals such as the ECG are derived from sensors that convert biological signals (such as pressure, flow, or mechanical movement) into electrical signals. In modern computerized monitors, these signals are digitized as close to the patient as possible.

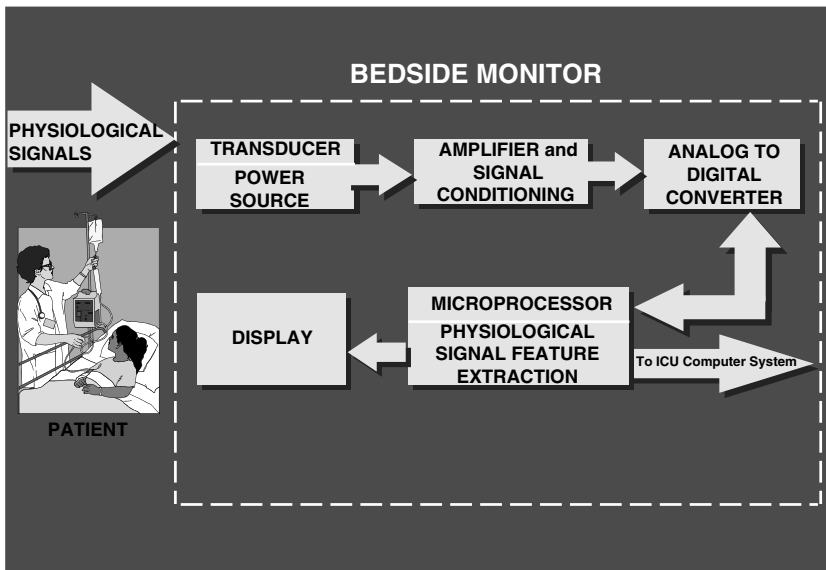
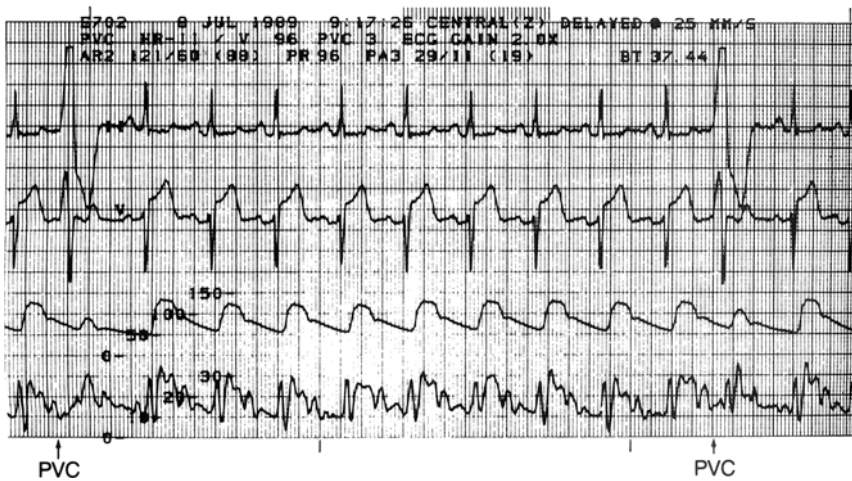

**Figure 17.3.** Block diagram of a modern Bedside Monitor. Physiological signals from the patient are acquired by transducers. These transducers convert the appropriate physiological signal into an electrical signal that is then amplified and conditioned (usually an analog filter of some sort) and then present the signal to an Analog to Digital converter (ADC). The ADC sends the data to a microprocessor based signal processor which extracts features such as heart rate and blood pressure. After processing, the physiological signals are displayed on a display device and usually sent to a centralized ICU display system and frequently to a electronic patient record.



Some biological signals are already in electrical form, such as the currents that traverse the heart and are recorded as the ECG. The ECG voltage signal derived from the electrodes at the body surface is small—only a few millivolts in amplitude. The patient is electrically isolated from the bedside monitor, and the analog ECG signal is amplified to a level sufficient for conversion to digital data using an analog-to-digital converter (ADC). Digital data then can be processed and the results displayed (Weinfurt, 1990, p. 130) (Figure 17.4).

As discussed in Chapter 5, the sampling rate is an important factor that affects the correspondence between an analog signal and that signal's digital representation. Figure 17.5 shows an ECG that has been sampled at four different rates. At a rate of 500 measurements per second (Figure 17.5a), the digitized representation of the ECG looks like an analog recording of the ECG. All the features of the ECG, including the shape of the P wave (atrial depolarization), the amplitude of the QRS complex (ventricular depolarization), and the shape of the T wave (ventricular recovery), are reproduced faithfully. When the sampling rate is decreased to 100 measurements per second, however, the amplitude and shape of the QRS complex begin to be distorted. When only 50 observations per second are recorded, the QRS complex is grossly distorted, and the other features also begin to distort. At a recording rate of only 25 measurements per second, gross signal distortion occurs, and even estimating heart rate by measuring intervals from R to R is problematic.



**Figure 17.4.** Electrocardiogram (first and second traces), arterial pressure (third trace), and pulmonary-artery pressure (fourth trace) recorded from a patient's bedside. Annotated on the recording are the bed number (E702), date (8 Jul 1989), and time (9:17:25). Also noted are a regular rhythm, a heart rate from the ECG (V) of 96 beats per minute, a systolic arterial pressure of 121, a diastolic pressure of 60, a mean pressure of 88 mm Hg, and a heart rate from pressure (PR) of 96. The patient is having premature ventricular contractions (PVCs) at a rate of three per minute; two PVCs can be seen in this tracing (at the beginning and near the end). The pulmonary-artery pressure is 29/11, with a mean of 19 mm Hg, and the blood temperature is 37.44°C. The self-contained monitoring system has determined the values and generated the calibrated graphical plot.

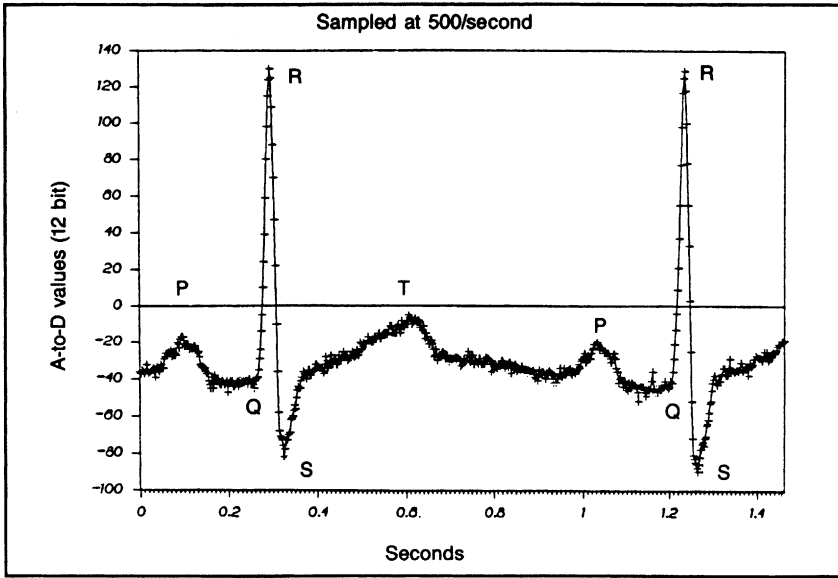

(a)

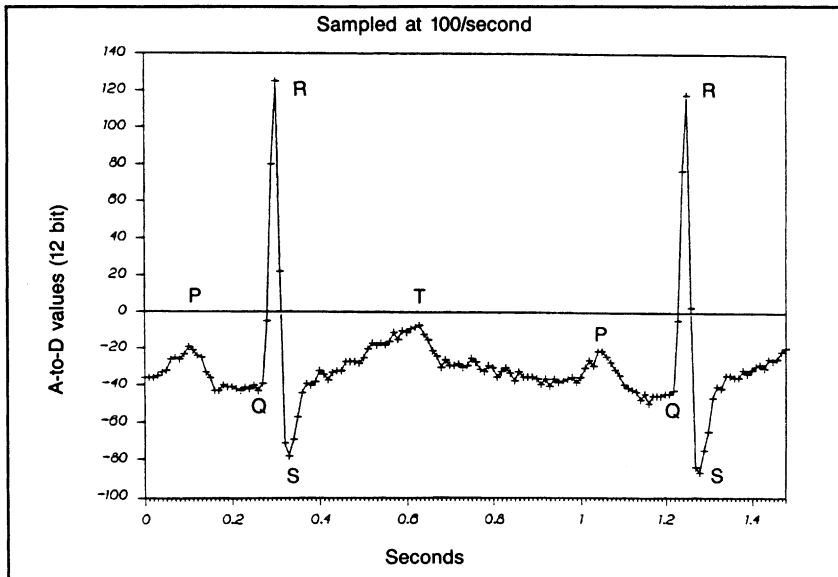

(b)

**Figure 17.5.** The sampling rate of the analog-to-digital converter determines the quality of the ECG. All four panels show the same ECG, sampled at different rates. Note the degradation of the quality of the signal as one proceeds from a to d. The ECG is sampled at 500 (a), 100 (b), 50 (c), and 25 (d) measurements per second.

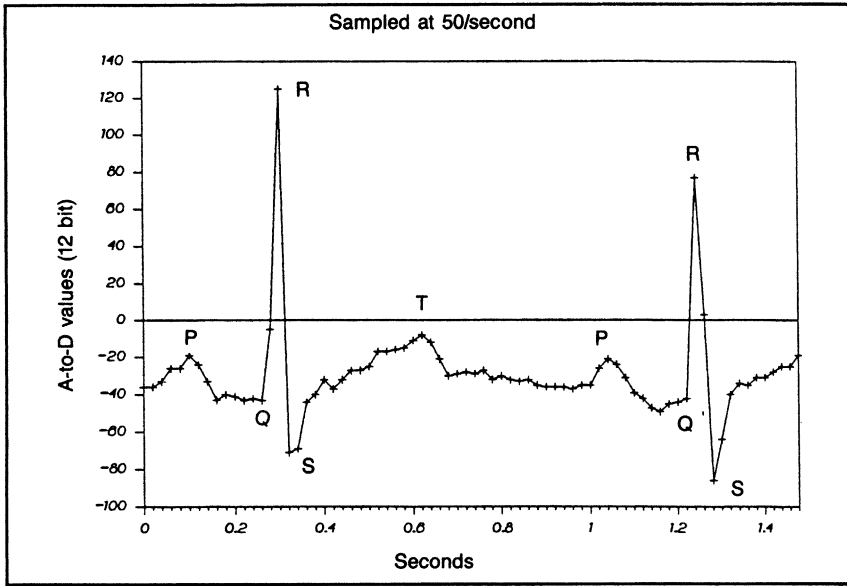

(c)

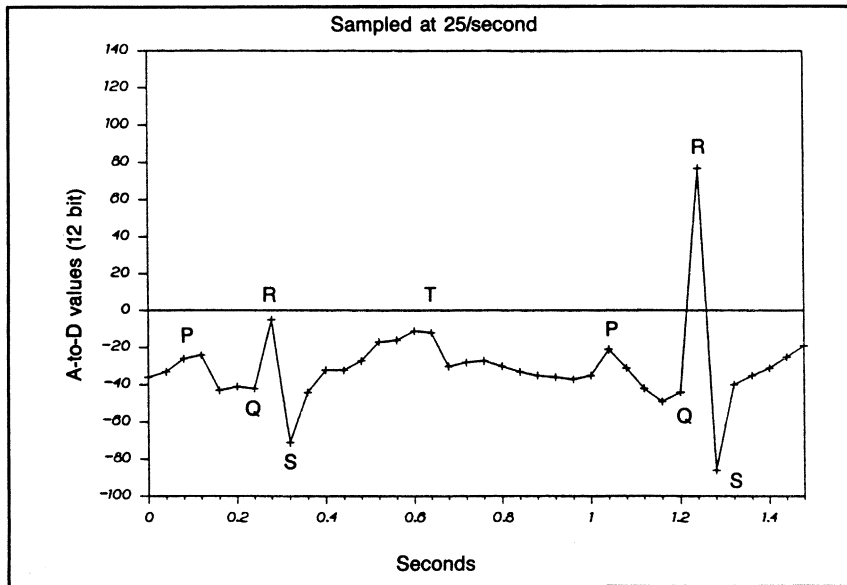

(d)

Figure 17.5. (Continued)

### 17.3.1 *Advantages of Built-In Microcomputers*

Today, bedside monitors contain multiple microcomputers, with much more computing power and memory than was available in the systems used by the computer monitoring pioneers. Bedside monitors with built-in microcomputers have the following advantages over their analog predecessors (Weinfurt, 1990):

- The digital computer's ability to store patient waveform information such as the ECG permits sophisticated **pattern recognition** and physiological signal **feature extraction**. Modern microcomputer-based bedside monitors use multiple ECG channels and pattern recognition schemes to identify abnormal waveform patterns and then to classify ECG arrhythmias.
- Signal quality from multiple ECG leads can now be monitored and interference noise minimized. For example, the computer can watch for degradation of ECG skin–electrode contact resistance. If the contact is poor, the monitor can alert the nurse to change the specified problematic electrode.
- Physiological signals can be acquired more efficiently by converting them to digital form early in the processing cycle. The waveform processing (e.g., calibration and filtering, as described in Chapter 5) then can be done in the microcomputer. The same process simplifies the nurse's task of setting up and operating the bedside monitor by eliminating the manual calibration step.
- Transmission of digitized physiological waveform signals is easier and more reliable. Digital transmission of data is inherently noise-free. As a result, newer monitoring systems allow health-care professionals to review a patient's waveform displays and derived parameters, such as heart rate and blood pressure, at the bedside, at a central station in the ICU, or at home via modem on a laptop computer. Figure 17.6 is a closeup of the signals and values from a typical bedside patient monitor.
- Selected data can be retained easily if they are digitized. For example, ECG strips of interesting physiological sequences, such as periods of arrhythmias (Figure 17.7), can be stored in the bedside monitor for later review. Today's monitors typically store all of the waveform data from multiple leads of ECG and blood pressure transducers for at least 24 hours and sometimes for even longer.
- Measured variables, such as heart rate and blood pressure, can be graphed over prolonged periods to aid with detection of life-threatening trends.
- Alarms from bedside monitors are now much "smarter" and raise fewer false alarms. In the past, analog alarm systems used only high–low threshold limits and were susceptible to **signal artifacts** (Gardner, 1997). Now, computer-based bedside monitors often can distinguish between artifacts and real alarm situations by using the information derived from one signal to verify that from another and can confidently alert physicians and nurses to real alarms. For example, heart rate can be derived from either the ECG or the arterial blood pressure. If both signals indicate dangerous tachycardia (fast heart rate), the system sounds an alarm. If the two signals do not agree, the monitor can notify the health-care professional about a potential instrumentation or medical problem. The procedure is not unlike that performed by a human verifying possible problems by using redundant information from simpler bedside monitor alarms. Despite these

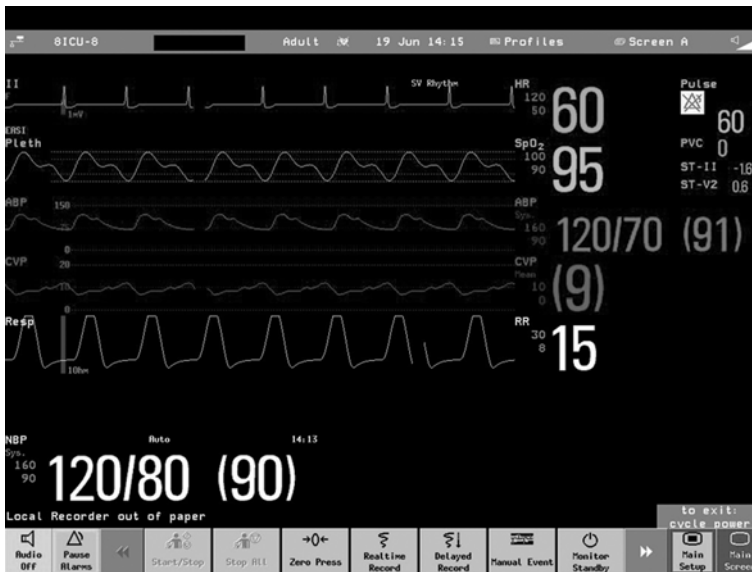

**Figure 17.6.** Close-up display of the screen of a modern bedside monitor showing physiological waveforms and numerical values derived from processing the displayed physiological data.

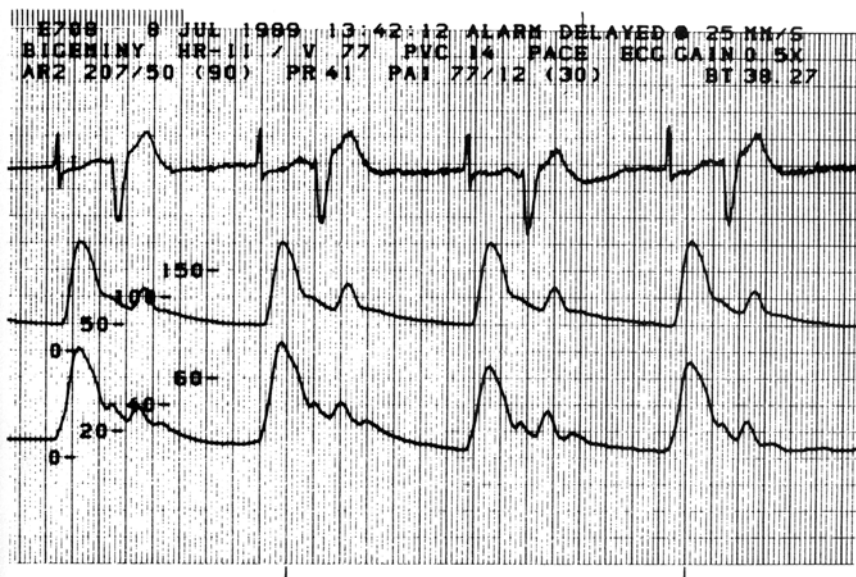

**Figure 17.7.** A strip showing a patient's ECG (upper trace) and arterial (middle trace) and pulmonary-artery (lower trace) pressure waveforms. The patient has a potentially life-threatening arrhythmia in which heart beats occur in pairs—a pattern called bigeminy. Note that, for two extra beats on the ECG pattern, the resulting pressure waveform pulsation is unusually small, indicating that the heart has not pumped much blood for that extra beat. The patient's heart rate, as determined from the ECG, is 77 beats per minute, whereas that determined from blood pressure is only 41 beats per minute. The heart is effectively beating at a very slow rate of 41 beats per minute.

advancements in bedside monitors, however, false alarms are still very prevalent (Tsien & Fackler, 1997, Koski et al 1995, Goldstein B 2003).

- Systems can be upgraded easily. Only the software programs in read-only memory (ROM) need to be changed; older analog systems required hardware replacement.

### 17.3.2 Arrhythmia Monitoring—Signal Acquisition and Processing

Although general-purpose computer-based physiological monitoring systems are now being more widely adopted, computer-based ECG arrhythmia-monitoring systems were accepted quickly (Weinfurt, 1990). Electrocardiographic arrhythmia analysis is one of the most sophisticated and difficult of the bedside monitoring tasks. Conventional arrhythmia monitoring, which depends on people observing displayed signals, is expensive, unreliable, tedious, and stressful to the observers. One early approach to overcoming these limitations was to purchase an arrhythmia-monitoring system operating on a time-shared central computer. Such minicomputer-based systems usually monitored 8 to 17 patients and cost at least \$50,000.

The newest bedside monitors, in contrast, have built-in arrhythmia-monitoring systems. These computers generally use a 32-bit architecture, waveform templates, and real-time feature extraction in which the computer measures such features as the R-R interval and QRS complex width; and template correlation, in which incoming waveforms are compared point by point with already classified waveforms (Weinfurt, 1990). Figure 17.8 shows the output from a commercial bedside monitor. Using signals from four ECG leads the computer has correctly classified a rhythm abnormality—in this

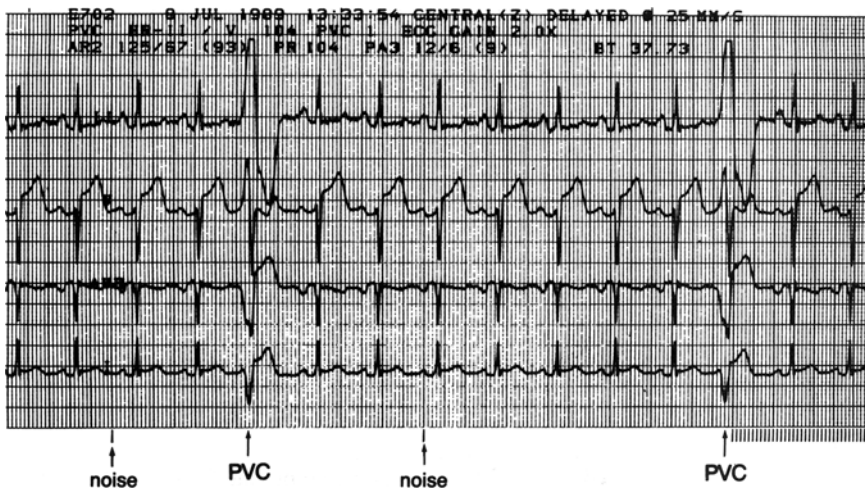

**Figure 17.8.** Two time-trend plots of systolic, mean, and diastolic pressure: a, 8 hours; b, 24 hours. Indicated across the bottom are the time of day at each of the tick marks. These plots show relatively stable blood-pressure trends over the 24-hour period.

case, a premature ventricular contraction (PVC). The bedside monitor also retains an ECG tracing record in its memory so that at a later time a health professional can review the information.

### Wave Form Classification

Computer algorithms for processing ECG rhythms take sampled data, such as those shown in Figure 17.5, and extract features, such as the amplitude and duration of the QRS complex (Weinfurt, 1990). In most schemes, each time the QRS detector is tripped, it signals a beat classification subprogram, which receives four channels of ECG data at the same time. Such a beat-classification scheme compares the waveform of each incoming beat with that of one or more clinically relevant waveform classes already established for the patient. If the new waveform matches any of those already classified, the “template” of that waveform class is updated to reflect any minor evolutionary changes in the shape. Most beat-classification schemes have the capacity to store up to 30 templates. The performance of these multilead monitors has been dramatic; however, such arrhythmia monitors are still not perfect.

Detecting and identifying pacemaker signals poses special problems for digital computer-based monitoring systems. Pacemaker signals do not reliably traverse the analog acquisition circuitry, and the pacemaker “spikes” are very narrow such that they can occur between data samples and be missed entirely. As a result, special analog “injection” methods are used to enhance the pacemaker “spike” so that it can be more easily detected (Weinfurt, 1990).

### Full-Disclosure and Multilead ECG Monitoring

Contemporary **central monitors** combine the advantages of digital waveform analysis as described above with high-capacity disk drives to store one or more days worth of continuous waveform data, including ECG. Some of these monitors can support recording full disclosure or synthesis of the entire 12-lead ECG on a second by second basis. Figure 17.9 shows a run of ventricular tachycardia in a portion of a 24-hour **full disclosure** ECG display. Figure 17.10 shows a bedside physiologic monitor displaying a Web page view of a full 12-lead ECG with computerized interpretations.

ST segment analysis of the ECG has also become very important because ST segment displacement is indicative of ischemic episodes of the heart muscle. Changes in open-heart procedure and administration of thrombolytic therapy are predicated on ST segment analysis. Multilead monitors now offer the opportunity to monitor ST segment changes.

### *17.3.3 Bedside Point of Care Laboratory Testing*

Over the past decade, laboratory chemical, hematologic, and blood gas testing processes have progressed from “wet” methods in which specific liquid reagents were mixed with blood or serum to perform analyses to a more or less “dry” phase in which analyses are performed by bringing a blood sample in contact with a reagent pack. Additional development has miniaturized both the blood-analysis cartridge and the blood-analysis

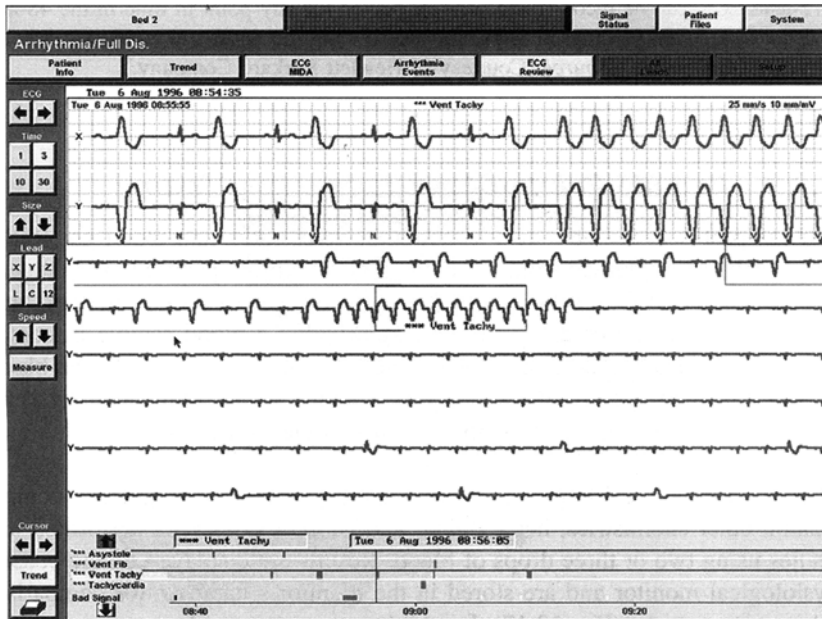

**Figure 17.9.** “Full disclosure” ECG display. This system stores continuous waveforms for 48 hours along with arrhythmia information. Waveforms may be displayed in a highly compressed format similar to Holter displays. (Source: Courtesy of Philips Medical Systems.)

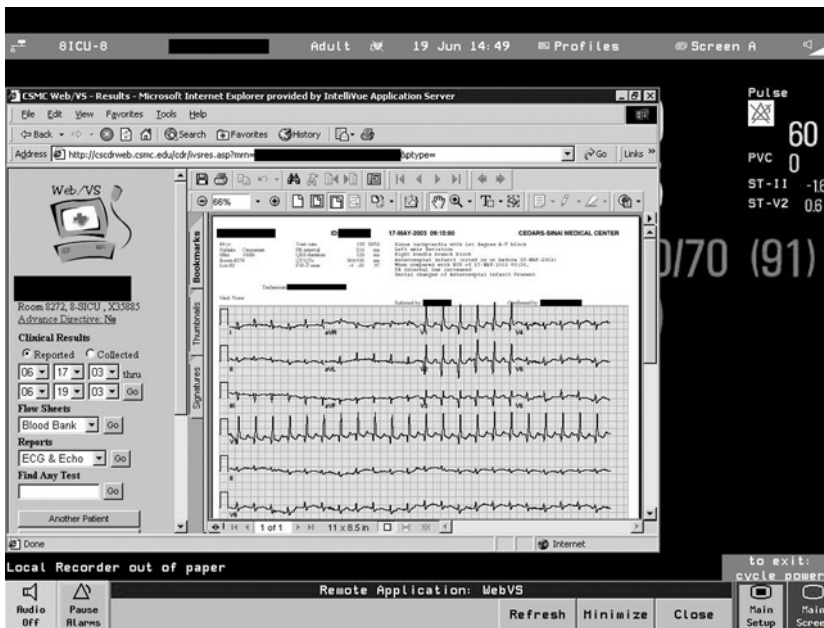

**Figure 17.10.** Web view of a “Full disclosure” 12-lead ECG with computerized ECG interpretations viewed on a bedside physiologic monitor. (Source: Courtesy of Dr. M. Michael Shabot)



machine to the point that the entire analysis system consists of a small plug-in module to a bedside physiological monitor (Figure 17.11).

Many laboratory tests, including pH,  $\text{Po}_2$ ,  $\text{Pco}_2$ ,  $\text{Hco}_3$ , electrolytes, glucose, ionized calcium, other chemistries, hemoglobin, and hematocrit, can be performed in 2 minutes using two or three drops of blood. Results are displayed on the bedside physiological monitor and are stored in the monitor's database for comparison with previous results (Figure 17.12). These laboratory results obtained at the bedside are also automatically transmitted through the monitoring network and hospital's backbone network to the laboratory computer system, and other systems as required, so that the results can be integrated into the patient's long-term records.

### 17.3.4 Commercial Development of Computer-Based Monitoring and Intensive-Care-Unit Information Systems

The development of central stations and integrated arrhythmia systems based on standard microcomputer-based server hardware and software platforms has led to wide-scale distribution in the clinical environment. These systems possess database and analysis functions previously reserved for larger systems, and well over 2000 such systems are in use in ICUs worldwide.



**Figure 17.11.** Blood analysis point of care device and a bedside physiological monitor. (Source: Courtesy of Philips Medical Systems.)

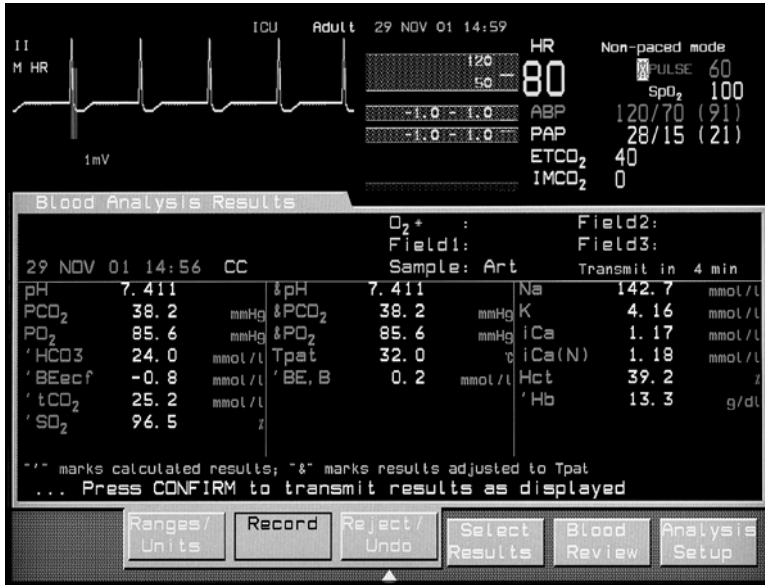

**Figure 17.12.** Philips Medical Systems IntelliVue Monitoring System physiological monitor display of bedside blood gas test results. Previous measurements are stored in the monitor and displayed with the current results. (Source: Courtesy of Philips Medical Systems.)

In recent years, the bedside monitor has become a focal point for data entry and presentation. In fact, most bedside monitoring systems sold today can also acquire and display data from clinical laboratories, bedside laboratory devices such as blood chemistry machines, and a host of other devices such as ventilators. Unfortunately each of these monitors has its own proprietary communications protocol and data acquisition scheme. As a result, the user community is faced with bedside monitors that function like “mini” patient-data-management systems. Furthermore, the desire to capture and manage all clinical data for patients in a critical care setting (not just patient monitoring data) has resulted in development of specialized ICU information systems (see Section 17.4). It is common for hospitals to acquire computer-based bedside monitors, which must be interfaced to an ICU information system, which in turn may be interfaced with a hospital’s clinical information system. Several large, capable, and reputable manufacturers have supplied over 350 computer-based ICU information systems worldwide. Three of the major companies involved in the development of such computer-based charting and monitoring systems are Philips Medical Systems with its CareVue system (Shabot, 1997b), GE Medical Systems formerly Marquette Electronic with its Centricity Clinical Information system, and Eclipsys (formerly EMTEK) with its Centrium 2000 computerized charting application (Brimm, 1987; Cooke & Barie, 1998).

During the time that commercially available physiological monitoring systems were being developed, imaging systems – **x-ray**, **computed tomography (CT)** and **magnetic resonance imaging (MRI)** were also undergoing major developments and transformations (See Chapter 18). Medical imaging plays a major role in the diagnosis and treatment of the critically ill. With most medical images now available in digital format it is now convenient for care providers to have fast and convenient access to medical images via the web. Figure 17.13 shows an abdominal CT scan from a patient at Cedars-Sinai Medical Center's ICU.

## 17.4 Information Management in the Intensive-care Unit

One of the goals of bedside patient monitoring is to detect life-threatening events promptly so that they can be treated before they cause irreversible organ damage or death. Care of the critically ill patient requires considerable skill and necessitates prompt, accurate treatment decisions. Healthcare professionals collect numerous data through frequent observations and testing, and more data are recorded by continuous-monitoring equipment. Physicians generally prescribe complicated therapy for such patients. As a result, enormous numbers of clinical data accumulate (Buchman, 1995; Kahn, 1994; Sailors & East, 1997; Shabot, 1995; Morris 2003). Professionals can miss

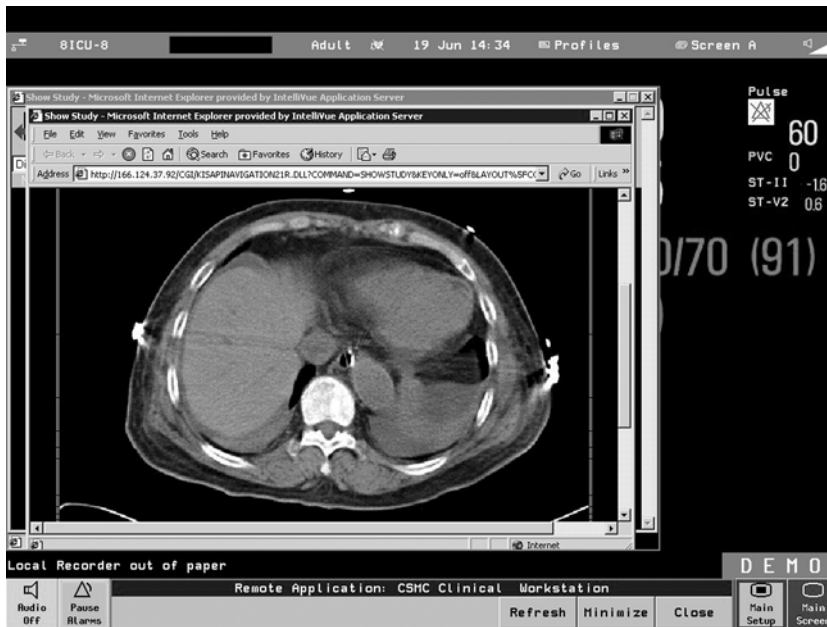

**Figure 17.13.** Abdominal CT image shown on a bedside physiologic monitor at Cedars-Sinai Medical Center (Source: Courtesy of Dr. M. Michael Shabot.)

important events and trends if the accumulated data are not presented in a compact, well-organized form. In addition, the problems of managing these patients have been made even more challenging by economic pressures to reduce the cost of diagnostic and therapeutic interventions.

Continuity of care is especially important for critically ill patients. Such patients are generally served by teams of physicians, nurses, and therapists. Data often are transferred from one individual to another (e.g., the laboratory technician calls a unit clerk who reports the information to a nurse who in turn passes it on to the physician who makes a decision). Each step in this transmission process is subject to delay and error. The medical record is the principal instrument for ensuring the continuity of care for patients.

### ***17.4.1 Computer-Based Charting***

As discussed in Chapters 2 and 12, the traditional medical record has several limitations. The problems of poor or inflexible organization, illegibility, and lack of physical availability are especially pertinent to the medical records of critically ill patients due to the large number of data collected and the short time allowed for many treatment decisions.

The importance of having a unified medical record was demonstrated by a study conducted at LDS Hospital in the mid-1980s (Bradshaw et al., 1984). Investigators kept detailed records of the data used by physicians to make treatment decisions in a shock–trauma ICU (Figure 17.14). The investigators were surprised to find that laboratory and blood-gas data were used most frequently (42 percent total), given that physiological bedside monitors are always present in the ICU. Clinicians' observations (21 percent) and drug and fluid-balance data (22 percent) also were used frequently. The bedside physiological monitor accounted for only 13 percent of the data used in making therapeutic decisions. These findings clearly indicate that data from several sources, not just from the traditional physiological monitoring devices, must be communicated to and integrated into a unified medical record to permit effective decision-making and treatment in the ICU. More recent studies by investigators at Stanford University and Cedars-Sinai Medical Center further support the need for integrated records and methods to assist in the “communal reasoning” required by the ICU team (Reddy, 2002).

To be effective, computer charting in the ICU must support multiple types of data collection. As Figure 17.14 shows, a large percentage of the data collected comes from what are typically manual tasks, such as administering a medication or auscultating breath or heart sounds. Furthermore, many instruments that present data in electronic form require their data to be observed by a person and entered into the patient chart. Thus, computer charting systems must be able to collect a wide variety of data from automated and remote sites, as well as from health-care providers at the bedside. Dictated and transcribed reports (e.g., history, physical, and X-ray reports) still represent a large and important source of computer readable but uncoded information for the clinical staff in an ICU. Unfortunately, most computer-charting systems have dealt with a limited set of the data that need to be charted (usually only the bedside monitoring data).

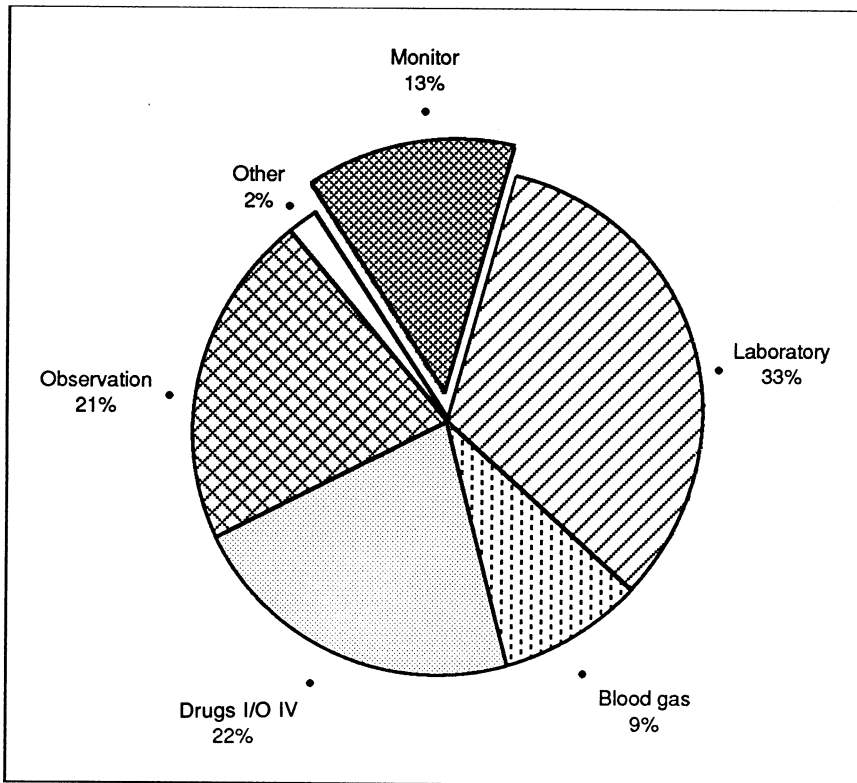

**Figure 17.14.** Pie chart indicating the variety of data physicians use when making treatment decisions in a shock–trauma intensive care unit. I/O input–output; IV intravenous.

Figure 17.15 illustrates the complexity of ICU charting. Modern computerized ICU flowsheet and medication administration record (MAR) displays are shown in Figures 17.16 and 17.17. The chart must document the actions taken by the medical staff to meet both medical and legal requirements (items 1 and 2 in Figure 17.15).

In addition, many of the data logged in the chart are used for management and billing purposes (items 3 and 4 in Figure 17.15). Many computer systems have ignored these requirements and thus have unwittingly forced the clinical staff to chart the same information in more than one place. Efficient management in hospitals is required, especially given the implementation of managed care strategies (see Chapter 23). Hospitals now have strong incentives to know the cost of procedures and to control these costs. As a result, it is necessary to know how sick the patient is, which in turn allows administrators to project nurse staffing needs and to account for the care of a patient by degree of illness. Communications (item 5 in Figure 17.15) to other departments within the hospital is mandatory. Access from office or home to clinical and administrative

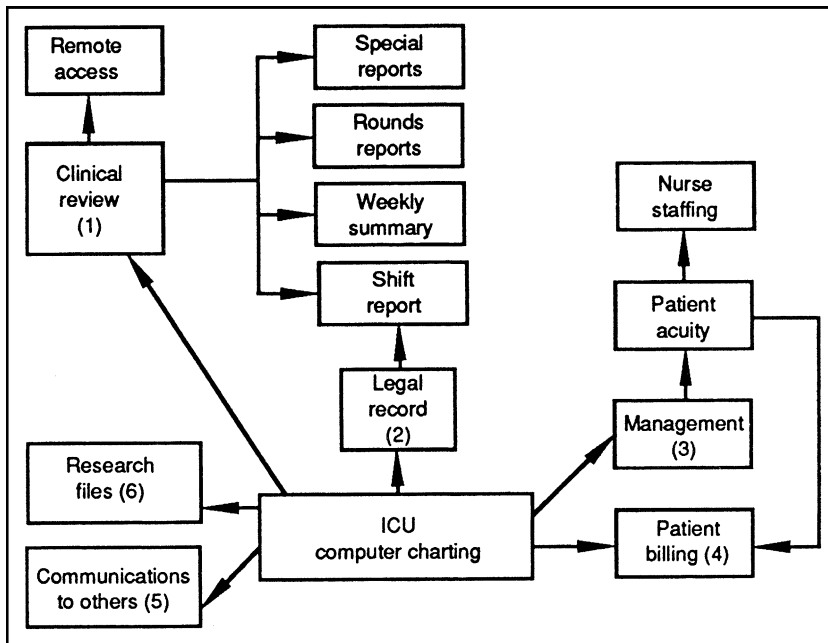

**Figure 17.15.** Block diagram showing the six major areas in which healthcare professionals interact with computer-based ICU charting to make patient care more effective and efficient. See text for explanations of functions. (Source: Reprinted with permission from Gardner R.M., Sittig D.F, Budd, M.C. [1989]. Computers in the intensive care unit: match or mismatch? In Shoemaker W.C., et al. (Eds.), *Textbook of Critical Care* (2nd ed, (p. 249). Philadelphia: W.B. Saunders.

Flowsheet		8SICU 3 8253 1.78m2 144.01b													
Main Menu   Actions   View   Print   CHART		?													
q1h Time Auto-charting q1h		85	8500	8600	0700	03May95 0800	0900	1000	1100	03May95 1200	1300	1400	1500	03May95 1600	
QUICK LOCK	Temp Site	.11	90.0	90.0	90.0	90.6	90.6	90.4	90.4	90.4	90.4	90.6	90.6	90.4	
VITALS GRAPH	Heart Rate	80	80	90	79	90	81	85	75	83	77	80	81	84	
LABS	SpO2	95	100/54	107/58	99/47	106/56	99/42	105/54	110/53	103/54	100/55	99/52	103/52	105/62	
VENT DATA	PA	14	29/15	26/13	27/12	29/13	25/12	28/14	27/12	32/15	32/18	33/20	31/18	34/20	
NURSE MISC	Qa/qc														
NEURO DETAIL	SpO2	90	90	90	90	90	90	90	90	90	90	90	90	90	
VASC DETAIL	Flow	50	50	50	50	50	50	50	50	50	50	50	50	50	
PI-CARE GRID	Flow	50	50	50	50	50	50	50	50	50	50	50	50	50	
SYSTEM ASSESS	Flow	50	50	50	50	50	50	50	50	50	50	50	50	50	
LINE ASSESS	Flow	50	50	50	50	50	50	50	50	50	50	50	50	50	
LAB I/O SUMMARY	Flow	50	50	50	50	50	50	50	50	50	50	50	50	50	
SICU MENU		ABG Results at 1645 May 03 95 Available Wed May 03 95 1740													

**Figure 17.16.** CareVue QuickLook Summary Display. The Quicklook display contains a summary of important data from different parts of the flowsheet. The content and appearance of the QuickLook display can be configured for each clinical area. (Source: M. Michael Shabot.)

Allergies: NKA		Date	Medication	Schedule	May 04 98	May 05 98
Scheduled	PRN	May 02 98	Accucheck 1U Diag q6h	0200		0200 1U...
			verified Jeannie Chen PharmD jgchen May 02 98 2320	0800 1400 2000		0800 1U... 1400 1U...
One-Time STAT			covered with regular insulin sliding scale Jeannie Chen PharmD jgchen May 02 98 2320			
ALL		May 02 98	Fluconazole inj 200mg IVPB q24h verified Jeannie Chen PharmD jgchen May 02 98 2326	2200	2200 200mg...	
		May 02 98	Ganciclovir inj 100mg IVPB q24h verified Jeannie Chen PharmD jgchen May 02 98 2326	2200	2200 100mg...	
		May 02 98	Lansoprazole cap 30mg PO bid verified Jeannie Chen PharmD jgchen May 02 98 2326	1000 2200	2200 30mg...	1000 30mg...
			same as prevacid Jeannie Chen PharmD jgchen May 02 98 2308			
		May 03 98	Linezolid inj 600mg IVPB q12h verified	1000 2200	2200 600mg... 2200 600mg...	
			investigational drug infuse over 2 hrs protect from light			
			Lipid 20% in1	0800		0800 500ml...

**Figure 17.17.** CareVue medication administration record (MAR) display. All medications are charted dose by dose in this system. (Source: M. Michael Shabot.)

information is a great convenience to physicians. Such communication is easier with a computer-based record. Because the computer-based ICU record is stored in the system, it is readily available for research purposes (item 6 in Figure 17.15). Anyone who has tried to retrieve data from manual patient charts for research purposes will recognize the value of the computer's capability.

To meet the clinical management needs required by critically ill patients as well as to provide an adequate legal record, most patient data-management systems generate a variety of reports. At the LDS Hospital, in addition to the rounds report shown in Figure 17.2, there are a variety of other reports. Figure 17.18 show a nursing shift report. The 12-hour report documents the physiological data and summarizes the laboratory data in its upper section. In the lower section, it displays a record of each drug given and each IV fluid administered. It lists the nurses who care for the patient; the nurses place their initials next to their names to indicate that they have verified the data. Total fluid-intake data are derived from the IV data, and fluid-output data are summarized as well. This allows a calculation of the net intake-output balance for the shift.

For the patient who is in the ICU for several days, a broader view of the course of the recovery process is essential. Thus, the system at LDS Hospital prepares weekly reports that summarize the data for each of the past seven 24-hour periods (Figure 17.19). The data already are stored in the computer, so no additional data entry is required to generate the report. A program abstracts and formats the data.

BERNICE # 10125 E704																						
AGE: 76	SEX: F	ADM WT: 50.00 KG	HT: 158 CM	BSA: 1.55 SQM	DR: MILLAR, ROGER CLIVE	SEQUENCE # 21																
P HR TEMP		JAN 28 89 18:01 JAN 29 89 06:00																				
SD "	C	18	19	20	21	22	23	0	1	2	3	4	5	6								
235	411	.....																				
220	401	.....																				
205	391	.....																				
190	381	.....																				
175	371	.....																				
160	361	.....																				
145	351	.....																				
130	341	.....																				
115	331	.....																				
100	321	.....																				
85	311	.....																				
70	301	.....																				
55	291	.....																				
40	281	.....																				
25	271	.....																				
10	261	.....																				
18	19	20	21	22	23	0	1	2	3	4	5	6										
WEIGHT (KG)		64.60																				
SLING WEIGHT																						
WAT (MMHG)	20	17	14	17	22	16	15															
PA SP (MMHG)	28	27	25	32	34	32	30															
PA DP (MMHG)	20	15	20	20	17	20																
PA MEAN (MMHG)	26	19	25	24	25	22	23															
PA WEDGE (MMHG)	16	12	17	18	20	15	18															
CO (L/MIN)																						
RESP RATE	16	21	24	28	19	23	22	20														
BLOOD GLU MG/DL		208																				
TUBE/DRAIN PH	8.0	7.0																				
OXIMETRY - SVO2	62	65	69	65	61	67	62	61														
OXIMETRY - ST02 (F)	94	92	93	92	93	90	87	92														
FOLEY CATH URINE	14	9	7	10	11	17	31															
TIME	CO	CI	HR	SV	SI	VP	MSP	MP	SVR	LWI	PW	PVR	RWI									
NORMAL HI	7.30	3.50	89	101	48	5.0	123	105	18	85	12	19	1.0	11.0								
NORMAL LOW	2.90	2.80	49	47	38	1.0	80	70	12	48	4	9	0.5	8.0								
JAN 28 05:00	4	10	2	47	111	37	22	15.0M	86	71	14	20	18	23	1.2	2.4						
JAN 28 22:44	DOBUTAMINE (DOBUINET) 2.00 MCG/KG/MIN																					
JAN 29 02:52	DOPAMINE (INTROPIN) 8.00 MCG/KG/MIN																					
JAN 29 04:16	EPINEPHRINE DRIP OR MCG/KG/MIN																					
SEVERE LV DYSFUNCTION																						
JAN 28 89 18:01 - JAN 29 89 06:00																						
.....																						
DIAZEPAM (VALIUM), INJ	2.5 MCG IV																					
CFCIXAXIME (CLAFORAN), INJ	1000 MCG IV																					
VECURONIUM BROMIDE (MORCURON), INJ	1 MCG IV																					
MANNITOL 25%, INJ	50 ML IV																					
FUROSEMIDE, INJ	100 MCG IV																					
BANITIDINE HCL (ZANTAC), INJ	50 MCG IV																					
MYLANIA II, LIQUID	30 ML NG																					
HEPARIN, INJ	1000 UNITS SUBQ																					
DSW, INJ	50 ML IV																					
MOLLEN REGULAR, INJ	3 UNITS IV																					
EIMACRYNIC ACID (EDECRIN), INJ	50 MCG IV																					
NORMAL SALINE, INJ	50 ML																					
DOPAMINE, INJ	210 MCG IV																					
DSW, INJ	2.000 MCG/KG/MIN																					
POTASSIUM CHLORIDE, INJ	35 ML																					
DS IN 0.2 NACL, INJ	3.6 MEQ IV																					
	180 ML																					
.....																						
JAN 28 89 18:01 TO JAN 29 89 06:00 MAUGHAN, ELOISE A. RN																						
INTAKE (ML):	NON-BLOOD IV	1750	OUTPUT (ML):	INSENSIBLE LOSS	470																	
	MG DRUG	120		FOLEY CATH URINE	99																	
	NS IRRIGATION	60		NG TUBE DRG	80																	
	TOTAL	1930		TOTAL	649	NET BALANCE	1281															
JAN 29 89	pH	PCO2	HCO3	BE	HB	CO/MT	PO2	SO2	OZCT	NO2	AVO2	VO2	C.O	A-a	Qs/Ql	PK/ PL/PP	MR/SR					
NORMAL HI	7.45	42.8	27.4	2.5	15.0	2/ 1	...	...	...	...	5.5	300	2.30	27	5							
NORMAL LOW	7.35	29.5	17.1	-2.5	11.9	0/ 1	54	87	15.8	...	3.0	200	2.90	0								
29 05:21 V	7.34	52.0	27.6	1.5	12.2	1/ 1	33	64	11.0	60	...	...	...	...	30/ 14/ 8	21/						
29 05:20 A	7.39	42.8	26.2	1.5	12.3	1/ 1	70	93	16.2	60	5.06	...	...	...	237	24	30/ 14/ 8	21/				
SAMPLE # 35, TEMP 37.6, BREATHING STATUS: ASSIST/CONTROL																						

Figure 17.18. Shift report for 12-hour ICU nursing shift at LDS Hospital. (Source: Courtesy of LDS Hospital.)



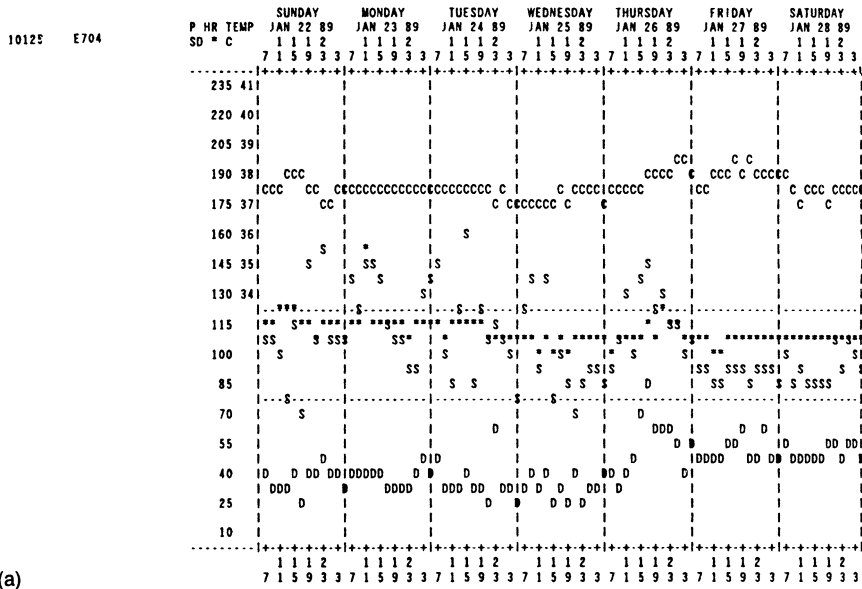

Figure 17.19. Two portions (a, b) of a weekly (7-day) ICU report, produced by the HELP system at LDS Hospital. The report provides a daily weight, fluid-balance, drug, and physiological-data summary for an individual patient. (Source: HELP System, LDS Hospital.)

Figure 17.20 shows a blood-gas report indicating the acid–base status of the patient’s blood, as well as the blood’s oxygen-carrying capacity. Note that, in addition to the numerical parameters for the blood, the patient’s breathing status is indicated. Based on all these clinical data, the computer provides an interpretation. For life-threatening situations, the computer prompts the staff to take the necessary action

### 17.4.2 Calculation of Derived Variables

Increased sophistication of hemodynamic, renal, and pulmonary monitoring resulted in the need to calculate **derived parameters**; for the first time, ICU staff had to crunch numbers. At first, pocket calculators were used, with each step performed by a careful nurse. Then programmable calculators took over this task, making the computation simpler, faster, and more accurate (Shabot, 1982; Shabot et al., 1977). Soon these devices were replaced by portable computers. Some of these systems also provided graphical plots and interpretations.

### 17.4.3 Decision-Making Assistance

One mark of a good physician is having the ability to make sound clinical judgments. Medical decision-making traditionally has been considered an intuitive, as well as a scientific, process. More recently, however, formal methods for decision-making have

		JAN 22	JAN 23	JAN 24	JAN 25	JAN 26	JAN 27	JAN 28
MORPHINE, INJ	MGM IV						7.0	6.0
ACETAMINOPHEN, SUPP	MGM RECT	37.0	21.0	2.0		1300	650	
DIAZEPAM (VALIUM), INJ	MGM IV						10.0	5.0
CEFOTAXIME (CLAFORAN), INJ	MGM IV							1000
GENTAMICIN, INJ	MGM IV						60.0	60.0
CEFUROXIME (ZINACEF), INJ	MGM IV	3000	3000	3000	3000	3000	3000	
DOBUTAMINE (DOBUTEX), INJ	MGM IV	732	582	792	810	270	87	222
EPINEPHRINE DRIP, INJ	MGM IV	22.20	11.46	3.96	0.00			1.53
VECURONIUM BROMIDE (NORCURON), INJ	MGM IV	39	26	18	13	10	3	7
DOPAMINE, INJ	MGM IV	648	492	420	396	522	864	738
METOLAZONE (ZAROXOLYN), TAB	MGM NG					5.00		
NITROPRUSSIDE (NIPRIDE), INJ	MGM IV	0						
AMRINONE (INOCOR), INJ	MGM IV	0						
FUROSEMIDE, INJ	MGM IV	80	80	80	80	120	80	280
MANNITOL 25%, INJ	ML IV							50
ETHACRYNIC ACID (EDECRIN), INJ	MGM IV							50
ACETAZOLAMIDE (DIAMOX), INJ	MGM IV			250	250		250	
RANITIDINE HCL (ZANTAC), INJ	MGM IV	150	100	150	150	150	150	150
MYLANTA II, LIQUID	ML NG		60	30	120	90	60	180
MYLANTA, LIQUID	ML NG			30	60			
HEPARIN, INJ	UNITS SUBQ						3000	6000
HEPARIN FLUSH, INJ	UNITS IV	400	300		300	500	200	100
ARTIFICIAL TEARS (LACRIL), SOLUTION	GTTS OPTH	6	4					
PLASMANATE 5%, INJ	ML IV						250	1400
PACKED RBC	ML IV					500		
ALBUMIN 25%, INJ	ML IV	100	50	50	150			
PLATELETS (RANDOM DONOR)	ML IV	400		150				
AMINOSYN 8.5%, INJ	ML IV	311	621	472	529	608	1079	617
POTASSIUM	MEQ IV	25.2	50.3	38.2	59.7	73.0	131.0	94.9
CALCIUM	MEQ IV	3.1	6.2	4.7	5.3	5.7	9.9	5.8
MAGNESIUM	MEQ IV	14.9	35.0	28.3	31.7	12.7	17.3	9.9
ZINC	MGM IV	3.4	6.8	5.2	5.8	6.7	11.9	6.4
COPPER	MGM IV	0.7	1.4	1.0	1.2	1.3	2.4	1.3
MANGANESE	MGM IV	0.3	0.6	0.5	0.5	0.6	1.1	0.6
CHROMIUM	MCG IV	6.8	13.7	10.4	11.6	13.4	23.7	12.7
CHLORIDE	MEQ IV	20.8	41.6	31.6	35.4	35.0	50.6	47.5
ACETATE	MEQ IV	24.9	49.7	37.8	42.3	41.5	69.7	52.2
PHOSPHATE	MEQ IV	14.9	29.8	22.7	25.4	65.8	138.5	45.5
SULFATE	MEQ IV	9.9	25.1	20.8	23.3	10.1	17.3	7.5
GLUCONATE	MEQ IV	3.1	6.2	4.7	5.3	5.7	9.9	5.8
FAT EMULSION 10% (LIPOSYN), INJ	ML IV							500
NORMAL SALINE, INJ	ML IV	6	2		2	154	10	40
FAT EMULSION 20% (LIPOSYN), INJ	ML IV	200	200	200	200	200	66	134
POTASSIUM CHLORIDE, INJ	MEQ IV	67.9	78.0	183.7	51.9	51.6	104.3	17.6
DSW, INJ	ML IV	410	215	25	150	5	10	
HETASTARCH (HESPAN), INJ	ML IV				250	0		
MAGNESIUM SULFATE 50%, INJ	GM IV	2.00						
NOVOLIN REGULAR, INJ	UNITS IV	18	15					3
-----								
INTAKE (ML): BLOOD		400		150		500		
COLLOID		100	50	50	150		250	1400
NON-BLOOD IV		2783	3046	2707	2395	2254	3145	3293
NG DRUG			50	50	180	90	60	180
TOTAL		3313	3216	2967	2815	2874	3485	5023
-----								
OUTPUT (ML): INSENSIBLE LOSS		937	946	943	873	1016	1077	939
FOLEY CATH URINE		360	740	210	902	2950	895	183
NG TUBE DRG.		50	200	80	125	40	75	260
WATERSEAL DRG, 1		180	50					
TOTAL		3918	3936	4023	2512	5226	2470	1382
-----								
NET BALANCE (ML):		-605	-720	-1056	303	-2352	1015	3641
-----								
WEIGHT (KG)		61.2	61.4	60.8	62.2	60.4	60.5	64.6
-----								
NUTRITIONAL: NP ENERGY	KCAL (IV)	1468	2143	1784	1803	1953	2813	2395
TOTAL ENERGY	KCAL (IV)	1573	2354	1944	1982	2160	3181	2605
-----								
PROTEIN	GM	26	53	40	45	52	92	52
FAT	GM	40	40	40	40	40	13	77
CHO	GM	315	513	407	413	456	789	464
NP ENERGY/N2	KCAL/GM	367	238	254	257	244	200	266
-----								
N2 IN	GM	4	9	7	7	8	14	9

BERNICE # 1012# E704

TIME OUT: JAN 29 89 13:53

PROCESS TIME: 00:18

(END)

Figure 17.19. (Continued)

been applied to medical problem-solving (see Chapter 3), and computer-assisted medical decision-making has gained wider acceptance (see the discussions of decision-support systems in Chapter 20). We now have the opportunity to use the computer to assist staff in the complex task of medical decision-making in the ICU. For example, the

## LDS HOSPITAL BLOOD GAS REPORT

STEVEN NO. 10072 DR. STINSON, JAMES B. RM E609  
 SEX: M AGE: 43

	pH	PCO2	HCO3	BE	HB	CO/MT	PO2	SO2	O2CT	%O2	AVO2	VO2	C.O.	A-a	Qs/Qt	PK/ PL/PP	MR/S		
JAN 05 89	---	---	---	---	---	---	---	---	---	---	---	---	---	---	---	---	---		
NORMAL HI	7.45	40.6	25.9	2.5	17.7	2/ 1	---	---	---	---	5.5	300	7.30	22	5				
NORMAL LOW	7.35	27.2	15.7	-2.5	13.7	0/ 1	64	91	18.5		3.0	200	2.90		0				
05 04:36 V	7.43	34.5	22.7	-.4	11.5	2/ 1	42	76	12.3	40						30/ 28/ 5	20/		
05 04:35 A	7.48	29.3	21.7		11.6	2/ 1	128	96	15.9	40	3.43			75	12		30/ 28/ 5	20/	
SAMPLE # 37, TEMP 37.3, BREATHING STATUS : ASSIST/CONTROL																			
MILD ACID-BASE DISORDER																			
MODERATELY REDUCED O2 CONTENT																			
SUPRA-NORMAL PO2																			
PULSE OXIMETER SO2 96.0																			
04 04:20 V	7.45	36.1	24.9	1.9	10.2	2/ 1	37	72	10.4	40							26/ 20/ 5	21/	
04 04:19 A	7.49	31.6	24.0	2.0	10.2	2/ 1	90	95	13.7	40	3.36	353	10.50	111	18		26/ 20/ 5	21/	
SAMPLE # 36, TEMP 37.5, BREATHING STATUS : ASSIST/CONTROL																			
MILD ACID-BASE DISORDER																			
SEVERELY REDUCED O2 CONTENT (13.7) DUE TO ANEMIA (LOW HB)																			
PULSE OXIMETER SO2 93.0																			
03 06:05 A	7.44	35.8	24.1	1.0	11.7	2/ 1	91	95	15.7	40				105			26/ 22/ 5	23/	
SAMPLE # 35, TEMP 37.0, BREATHING STATUS : ASSIST/CONTROL																			
NORMAL ARTERIAL ACID-BASE CHEMISTRY																			
MODERATELY REDUCED O2 CONTENT																			
PULSE OXIMETER SO2 93.0																			
02 04:16 V	7.46	37.4	26.4	3.4	9.1	1/ 1	35	71	9.1	40							32/ 25/ 10	20/	
02 04:15 A	7.51	32.4	25.8	3.9	9.5	2/ 1	91	95	12.8	40	3.29	237	7.20	109	17		32/ 25/ 10	20/	
SAMPLE # 34, TEMP 37.1, BREATHING STATUS : ASSIST/CONTROL																			
MODERATE METABOLIC ALKALOSIS																			
SEVERELY REDUCED O2 CONTENT (12.8) DUE TO ANEMIA (LOW HB)																			
PULSE OXIMETER SO2 95.0																			
01 10:53 A	7.47	37.0	26.8	4.0	11.1	1/ 1	77	94	14.7	60				238			36/ 27/ 10	20/	
SAMPLE # 33, TEMP 37.7, BREATHING STATUS : ASSIST/CONTROL																			
MILD ACID-BASE DISORDER																			
MODERATELY REDUCED O2 CONTENT																			
PULSE OXIMETER SO2 93.0																			
01 03:59 V	7.41	46.2	29.0	4.5	10.0	1/ 1	42	73	10.2	80							/	/ 12	20/
01 03:58 A	7.46	39.2	27.7	4.5	9.9	1/ 1	146	97	13.7	80	3.64	331	9.10	287	23		/	/ 12	20/
SAMPLE # 32, TEMP 38.4, BREATHING STATUS : ASSIST/CONTROL																			
MILD ACID-BASE DISORDER																			
SEVERELY REDUCED O2 CONTENT (13.7) DUE TO ANEMIA (LOW HB)																			
SUPRA-NORMAL PO2																			
01 00:39 A	7.44	42.2	28.4	4.7	10.0	1/ 1	104	95	13.5	90				386			/	/ 10	20/
SAMPLE # 31, TEMP 38.9, BREATHING STATUS : ASSIST/CONTROL																			
MILD ACID-BASE DISORDER																			
SEVERELY REDUCED O2 CONTENT (13.5) DUE TO ANEMIA (LOW HB)																			
PULSE OXIMETER SO2 91.0																			
31 23:35 A	7.42	42.4	27.2	3.2	10.1	1/ 1	63	87	12.3	65				276			/	/ 5	20/
SAMPLE # 30, TEMP 39.0, BREATHING STATUS : ASSIST/CONTROL																			
MILD ACID-BASE DISORDER																			
MODERATE HYPOXEMIA																			
SEVERELY REDUCED O2 CONTENT (12.3) DUE TO ANEMIA (LOW HB)																			
PULSE OXIMETER SO2 83.0																			
31 16:00 A	7.49	34.4	26.1	3.8	9.7	1/ 1	87	95	13.1	40				111			/	/ 5	21/
SAMPLE # 29, TEMP 37.8, BREATHING STATUS : ASSIST/CONTROL																			
MILD ACID-BASE DISORDER																			
SEVERELY REDUCED O2 CONTENT (13.1) DUE TO ANEMIA (LOW HB)																			

PRELIMINARY INTERPRETATION -- BASED ONLY ON BLOOD GAS DATA. \*\*\* (FINAL DIAGNOSIS REQUIRES CLINICAL CORRELATION) \*\*\*  
 KEY: CO=CARBOXY HB, MT=MET HB, O2CT=O2 CONTENT, AVO2=ART VENOUS CONTENT DIFFERENCE (CALCULATED WITH AVERAGE OF A & V HB VALU  
 VO2=OXYGEN CONSUMPTION, C.O.=CARDIAC OUTPUT, A-a=ALVEOLAR arterial O2 DIFFERENCE, Qs/Qt=SHUNT, PK=PEAK, PL=PLATEAU, PP=PE  
 MR=MACHINE RATE, SR=SPONTANEOUS RATE. \*\*\* SPECIMEN IDENTIFICATION: BLOOD (A=ARTERIAL, V=VENOUS, C=CAPILLARY, W=WEDG  
 FLUIDS (P=PLEURAL, J=JOINT, B=ABDOMINAL, S=ABSCCESS); E=EXPIRED AIR;  
 ECCO2R (I=INFLOW, M=MIDFLOW, O=OUTFLOW)

KEEP FULL PAGE FOR RECORDS  
 (END)

**Figure 17.20.** Blood-gas report showing the patient's predicted values, as well as the measured values. The computer provides a decision-making interpretation and alerting facility. Note that this report summarizes, in reverse chronological order, the patient's blood-gas status over the course of 8 days. (Source: Courtesy of LDS Hospital.)

HELP computer system at the LDS Hospital in Salt Lake City has been used effectively to assist in ICU antibiotic use decision-making (Evans et al., 1998; Garibaldi, 1998). The so called “antibiotic assistant” provides recommendations as to the specific antibiotic recommended for a specific patient and further recommends the dose to be given and the mode of delivery (for example IV) also based on the patient’s size and renal function (Figure 17.21). The system collects and integrates data for the ICU patient from a wide variety of sources. The data are processed automatically by the HELP decision-making system to determine whether the new information, by itself or in combination with other data in the patient record (such as a laboratory result or a previously generated decision), leads to a new medical decision. These computer-generated medical decisions are based on predefined criteria stored in the system’s knowledge base.

The HELP decision-making system has been used in the following areas:

- Interpretation of data; for example, interpretation of breathing status based on blood-gas reports and hemodynamic parameters
- Alerts; for example, notification that a drug is contraindicated at the time the drug is being ordered

```

4700XXXX PUBLIC, JOHN Q.  E799   58yr M      Dx: CAD
-Max 24hr WBC= 9.4 ↓(14.3)      Admit:      07/15/03.01:30Max 24hr Temp=38.1 ↓ (38.2)
-RENAL FUNCTION: Impaired, CrCl = 35, Max 24hr Cr= 1.7 ↑ ( 1.6)  IBWeight: 70kg
-ANTIBIOTIC ALLERGIES: Penicillins,
-CURRENT ANTIBIOTICS:
1. 07/30/03 13days  FLUCONAZOLE IN NS (DIFLUCAN),  IVPB 200.      Q 24 hrs
2. 08/02/03 13days  IMIPENEM/CILASTATIN (PRIMAXIN),  VIAL 500.      Q 12 hrs
3. 08/08/03 4days  LEVOFLOXACIN/D5W(LEVAQUIN),      PIGGYBACK 250. Q 24 hrs
-IDENTIFIED PATHOGENS      SITE      COLLECTED
p Enteric bacilli          Sputum    08/07/03.11:13
-ANTIBIOTIC SUGGESTION      DOSAGE    ROUTE    INTERVAL
Imipenem                   500mg    IV       *q12h    (infuse over 1hr)
Suggested Antibiotic Duration: 10 days
* Adjusted based on patient's renal function.
p=Susceptibilities based on antibiogram or same pathogen w/ susceptibilities.
NOTE: Cephalosporins, imipenem and penicillins can cross react if allergy
includes urticaria or bronchial spasms or laryngeal spasms. Alternate choice:
Levofloxacin *250mg IV q24h (500mg initial dose)
<1>Micro, <2>OrganismSuscept, <3>Drug Info, <4>ExplainLogic, <5>Empiric Abx,
<6>Abx Hx, <7>ID Rnds, <8>Lab/Abx Levels, <9>Xray, <10>Data Input Screen,
<Esc>EXIT, <F1>Help, <0>UserInput, <.>OutpatientModels, <+orF12>ChangePatient,
ORDER:<*>Suggested Abx, <Enter>Other Abx, </>D/C Abx, <->Modify Abx,

```

**Figure 17.21.** Display of a screen from the Antibiotic Assistant at LDS Hospital. Screen shows important patient information such as maximum temperature, microbiology data and then makes recommendations for medication with its dose, route of administration and recommended duration (Source: Courtesy of Dr. R. Scott Evans at LDS Hospital).

- Diagnoses; for example, detection of hospital-acquired infections
- Treatment suggestions; for example, suggestions about the most effective antibiotics to order

The ICU component of HELP is one of the most mature of the system's clinical applications. The basic requirements for data acquisition, decision support, and information reporting are similar for patients in the ICU and on the general patient-care units of the LDS Hospital. The number of variables and the volume of observations that must be integrated, however, are much greater for patients in the ICU.

At Cedars-Sinai Medical Center, all laboratory and flowsheet data are continuously analyzed for critical laboratory results and adverse combinations of clinical (nonlaboratory) events. When such events are detected, they are transmitted to the responsible physician via an encrypted alphanumeric pager. Figure 17.22 shows a low Serum Potassium laboratory alert ( $K^+$  2.8), and Figure 17.23 warns of a critical Penicillan allergy sent by an encrypted transmission to a BlackBerry™ device.

#### 17.4.4 Response by Nurses and Physicians

Currently, bedside terminals are functioning in all ICUs at LDS Hospital, and nurses use a computer-based system to create nursing care plans and to chart ICU data. The goals of automation were (1) to facilitate the acquisition of clinical data, (2) to improve

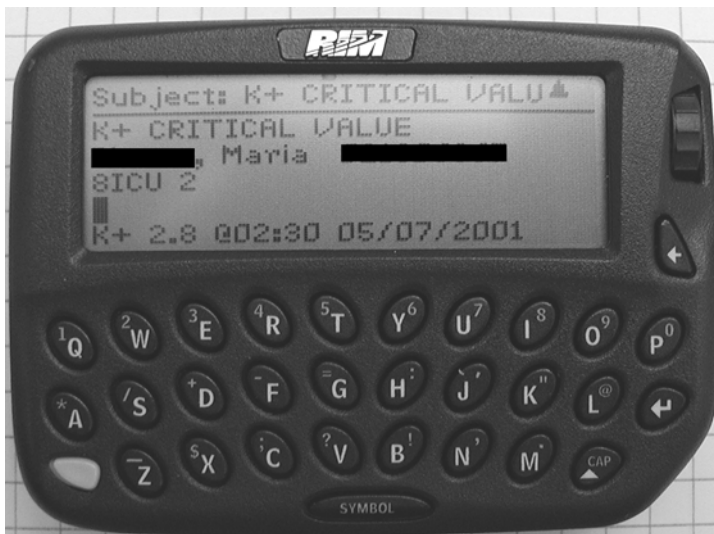

**Figure 17.22.** A BlackBerry™ alphanumeric pager displays a real-time alert message for a serum potassium level of 2.8 mg/dl. All laboratory data coming into CareVue is transferred to another computer system where it is run through a rules engine, which generates the pager alert messages at Cedars-Siani Medical Center (*Source:* Courtesy of Dr. M. Michael Shabot).

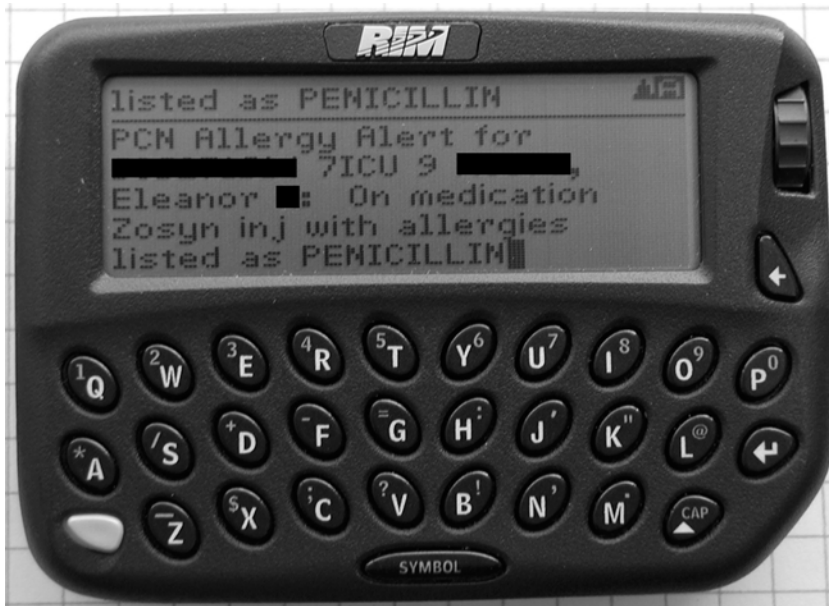

**Figure 17.23.** A Blackberry™ alphanumeric pager displays an alert for a potentially serious drug allergy at Cedars-Siani Medical Center (*Source:* Courtesy of Dr. M. Michael Shabot).

the content and legibility of medical documentation, and (3) to increase the efficiency of the charting process so that nurses could devote more time to direct patient care. Studies have shown wide acceptance by nurses and physicians of the HELP system and its decision-support capabilities (Gardner & Lundsgaarde, 1994). Also, the content and quality of nursing charts has improved markedly (Bradshaw et al., 1988). To date, however, the studies have not shown improvements in the efficiency of information management by ICU nurses (time savings) that could be credited to use of the system.

The lack of demonstrable time savings may be due to several factors. First, the new system affected only selected aspects of the nursing process. For example, physiological and laboratory data were already acquired automatically, so the effects of these computer-based systems were not included in the analyses. Second, the computer-based charting system is not yet comprehensive; nurses still hand write some data in the patient chart. Third, nurses do not always take advantage of the capabilities of the charting system. For example, they sometimes reenter vital signs that have already been stored in the computer. Fourth, the intervals of time saved may have been too small to be measured using the work-sampling methods employed in the studies. Fifth, these small savings in time are easily absorbed into other activities. Despite the lack of widespread improvement in efficiency, the clinical staff at LDS Hospital are enthusiastic about using computers (Gardner & Lundsgaarde, 1994).

At Cedars-Sinai Medical Center, a national healthcare consulting firm was employed in 1989 to measure time savings associated with the computerized system in the surgical ICUs compared with the standard paper charting system in noncomputerized ICUs. The consultants drew their conclusions from observations of caregiver activities in both kinds of ICUs, as well as from detailed interviews. They concluded that the system saved about 20 percent of the nurses time spent in charting, about 25 percent of surgical residents' time reviewing data, and about 33 percent of attending surgeons' time reviewing data (Dorenfest and Associates, 1989, Chicago, IL, unpublished report). In addition a "vision" of what technology can do for nursing has recently been presented by Dr. Shabot (Shabot 2003).

## 17.5 Current Issues in Patient Monitoring

As more health services are shifted to outpatient settings, the acuity of hospitalized patients continues to increase; thus, the future of computer-based ICU monitoring systems is bright. Developments in bedside monitors have accelerated because of the availability of more powerful and affordable microcomputers. Nonetheless, some important areas of research in patient monitoring have not yet been addressed effectively.

### 17.5.1 Data Quality and Data Validation

There are still major problems with acquiring ICU data either automatically or manually (Gardner, 1997, p. 126). A system must provide feedback at various levels to verify correct operation, to carry out quality control, and to present intermediate and final results. As discussed earlier, some **cross validation** between signals is possible, but this process is performed by very few of the bedside monitors in use today. An ICU study of early, standalone pulse oximetry monitors revealed that up to 46.5 percent of low saturation alarms were neither observed nor responded to by any caregiver in large part due to constant false alarms associated with such devices (Bentt et al., 1990). Some newer patient-monitoring devices, such as integrated pulse oximeters and direct pressure measuring systems, have built in noise-rejection algorithms to improve the quality of the data presented (Gardner et al., 1986). Data validation, however, is one area of patient monitoring that still offers much opportunity for technological development and improvement (Dalto et al., 1997; Strong et al., 1997; Young et al., 1997). Figure 17.24 illustrates a problem with manual charting of data from bedside devices. During an implementation of IV pumps with the **Medical Information Bus (MIB)** at one of our hospitals, we had nurses chart "manually" and also logged IV drip rate changes with the MIB. Shown in Figure 17.24 are the "time delays" between the time an IV drip rate was "changed" and when the data were logged into the electronic medical record. Note that only about 1/3 of the drip rate changes were logged within 10 minutes of the change. Also note it took over 190 minutes to have 90% of the rate changes charted. Then, even at 300 minutes only 95% of the changes were charted. Physicians and nurses will recognize such a charting practices as waiting until the "end of shift" to log ALL the results. Such a manual charting process not only makes it impossible to follow what is going on

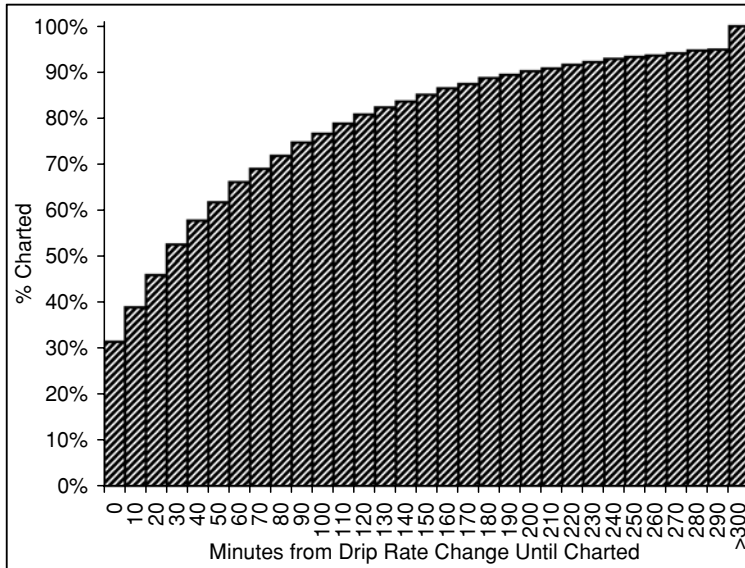

**Figure 17.24.** IV Charting comparison – Delay time between when an IV drip rate actually occurred and it was manually charted by a nurse in the ICU. Horizontal axis is the time in minutes and the vertical axis is the cumulative percentage of values that are recorded within each of the 10 minute time slots. For example in the first 10 minutes about 33% of drip rates would have been entered into a bedside manual charting system.

with the patient – for example, if a **vasoactive drug** caused the blood pressure to stabilize, but can also lead to major treatment errors. Surprisingly, these same types of delays were seen with simple IV fluid infusions such as normal saline, but were also seen with important, short vasoactive medication agents.

### 17.5.2 *Continuous Versus Intermittent Monitoring*

One of the persistent questions facing people who monitor patients is: Should I measure a parameter continuously, or is intermittent sampling enough? A related question is: How often do I make the measurement? These questions have no simple answer. If we are measuring the ECG and want to display it continuously, we must sample the signal at a rate of at least twice the rate of the maximum frequency of interest in the signal (the Nyquist frequency; see Chapter 5). Thus, for an ECG, the sampling rate should be at least 200 measurements per second.

To perform intermittent monitoring—periodic measurement of blood pH, for example—the overriding concerns in determining sampling rate are how rapidly the parameter can change, and how long before a dangerous change will result in irreversible damage. Sudden heart stoppage or severe dysrhythmias are the most frequent causes of sudden death. Therefore, heart-rate and rhythm monitors must function continuously



and should sound alarms within 15 to 20 seconds after detecting a problem. Other physiological parameters are not as labile and can be monitored less frequently. For the most part, medical measurements are made intermittently, and even continuously measured parameters are displayed at intervals. For example, heart rate can change with each beat (by 0.35 to 1 second). To provide data that a human can interpret, however, a bedside monitor usually updates its display every 3 seconds.

### 17.5.3 Data Recording: Frequency and Quantity

In the past, because analog and early digital bedside monitors and central stations could not store continuous waveforms from all patients, it was acceptable for nurses to archive periodic strip chart recordings (“snapshots”) in the patient’s ICU chart. Most ICUs have policies and procedures for pasting waveform recordings during the nursing shift and for critical events. The newer central stations, however, record digitized waveforms to hard disk on a continuous basis, and theoretically these data could be archived with the patient’s electronic chart or printed out for a paper chart. But must second-by-second waveform data be archived permanently? Will it improve the quality of patient care? Or will it simply increase the cost of care in the form of increased magnetic or optical storage media, paper usage, and material for lawyers to haggle over for years to come?

There is a worrisome precedent with fetal monitoring recordings (See Figure 17.25): When it became possible to make a continuous record—first on paper and more recently in electronic form — it became mandatory for hospitals to do so. The fate of continuous recordings of routine ICU waveforms remains to be decided.

### 17.5.4 Invasive Versus Noninvasive Monitoring

Physiological and biochemical parameters commonly used in monitoring can be measured by instruments and devices that are either invasive (require breaking the skin or entering the body) or noninvasive. After several decades of development of **invasive techniques**, the recent trend has been to design **noninvasive methods**. Much of the

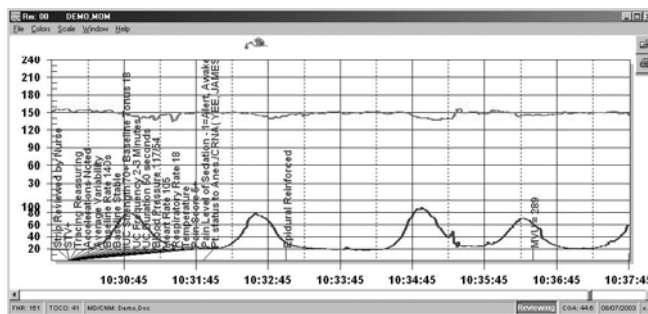

Figure 17.25. Stork-bytes. (Source: Courtesy of LDS Hospital.)

development of noninvasive technology can be attributed to the availability of microcomputers and solid-state sensors.

The development of inexpensive light-emitting diodes (LED), small solid-state light detectors, and new computer methods made possible, for example, the development of the *pulse oximeter*, an exciting example of noninvasive monitoring technology. When alternately red and then infrared light is shined from the LEDs through a finger or an ear, the device can detect the pulsations of blood and determine arterial oxygen saturation and heart rate (Severinghaus & Astrup, 1986). Pulse oximetry is one of the most significant technological advances ever made in monitoring. The technology is quite reliable, yet inexpensive, and, because it is noninvasive, it does not subject the patient to the costs and risks of invasive techniques (e.g., infection and blood loss). Recently several manufacturers have produced “next-generation oximeters” (Health Devices 2003). These newer pulse oximeters use advanced signal-processing algorithms that allow the devices to eliminate motion artifact and detect poor perfusion. As a consequence of these improvements, the quality of the derived signals and the number of false alarms have been dramatically reduced.

### ***17.5.5 Integration of Patient-Monitoring Devices***

Most bedside patient-support devices, such as IV pumps, ventilators, and physiological monitors, are microcomputer based. Each has its own display and, because each comes from a different manufacturer, each is designed as a standalone unit. As a result, it is common for a nurse or therapist to read a computer display from one of these devices and then to enter the data through a workstation into a different computer. The need to integrate the outputs of the myriad devices in the ICU is apparent. The absence of standards for medical-device communications has stymied the acceptance and success of automated clinical data management systems. Due to the large number and variety of medical devices available and to the peculiar data formats, it is impractical to interface the growing number of bedside devices to computers by building special software and hardware interfaces. For these reasons, an Institute of Electrical and Electronic Engineers (IEEE) **Medical Information Bus (MIB)** standards committee 1073 was established (Dalto et al., 1997; Kennelly & Gardner, 1997; Shabot, 1989; Wittenber & Shabot, 1990; Young et al., 1997). Automated data capture from bedside medical devices is now possible using the IEEE 1073 communications standards.<sup>5</sup> With these standards in place, it is possible for vendors and hospitals to implement “plug and play” interfaces to a wide variety of bedside medical devices such as bedside monitors, IV pumps, and ventilators.

Work at LDS Hospital (Gardner et al., 1992) and many other medical centers using the MIB has demonstrated that the use of a common bus system facilitates timely and accurate data acquisition from bedside devices such as pulse oximeters, ventilators, infusion pumps, pH meters, and mixed venous oxygen saturation monitoring systems. As a result of the standardization of MIB, it is much easier to establish communications with these devices in the ICU (Figure 17.26). The larger information challenges in the ICU

---

<sup>5</sup><http://ieee.1073.org>.

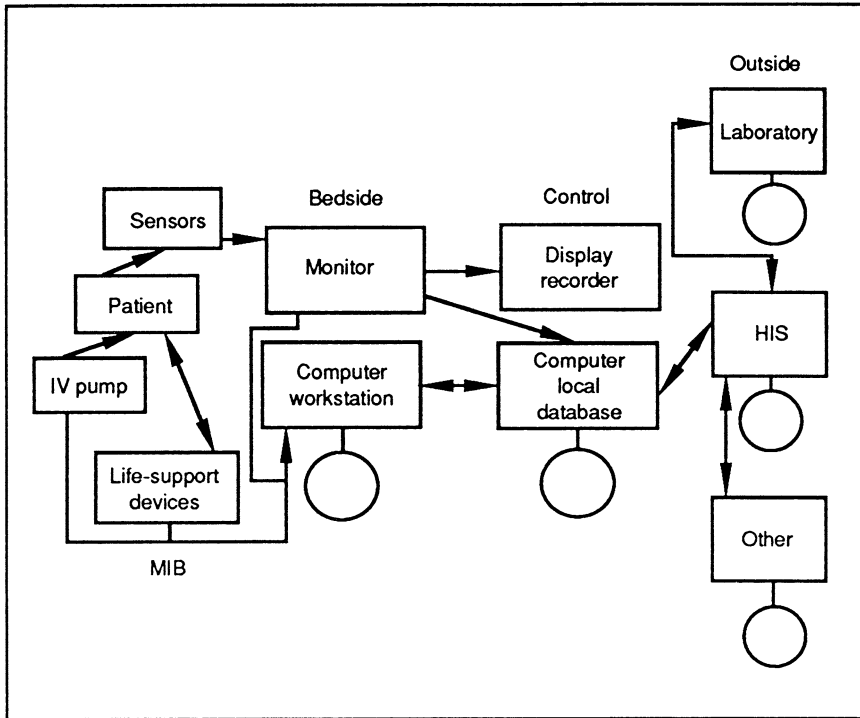

**Figure 17.26.** Block diagram of a distributed-database ICU system with networking. The database has been distributed to improve response time and reliability; the communications network has been implemented to enhance the integration function needed to care for the critically ill patient. MIB5medical information bus; HIS5hospital information system; IV5intravenous.

now include integration of patient-monitoring data and observations charted by clinicians within ICU management systems and subsequent integration of the critical-care records with the overall computerized patient record (Chapter 12).

### 17.5.6 Closed-Loop Therapy

The natural outcome from the remarkable developments noted above would seem to be **closed-loop control** of physiological processes. It can be argued that pacemakers and implantable defibrillators are such devices. In the ICU, however, precisely controlled intravenous pumps are available for drug infusions, and there is no shortage of digitized physiological signals available at the bedside and on the monitoring network. Despite Sheppard (Sheppard 1968) and colleagues' pioneering work in automated blood infusion therapy after open-heart surgery 35 years ago, however, very few examples exist of successful similar work. Although a closed-loop nitroprusside pump was marketed briefly a few years ago, no commercial products are available at this time. The major

impediments include the difficulty of creating closed-loop systems with tolerance for the kind of artifacts and measurement errors seen in ICU patients and the difficult medicolegal environment in many industrialized countries.

### ***17.5.7 Treatment Protocols***

As in other areas of medical practice, there is considerable interest in developing standard treatment protocols to improve the consistency, quality, and cost effectiveness of critical-care settings. Two different examples will demonstrate the value of treatment protocols in the ICU. The first is an expert system for management of mechanical ventilation, and the second is a computer-assisted management program for antibiotics. Researchers at LDS Hospital initially implemented a program to manage the therapy of patients who have Adult Respiratory Distress Syndrome (ARDS) and who were enrolled in a controlled clinical trial (Sittig, 1987). More recently a broader set of protocols has been developed (East et al., 1992). These computerized protocols were developed to standardize therapy, ensure uniformity of care, provide equal intensity and frequency of monitoring, improve the consistency of decision-making strategies, and achieve common therapeutic goals. The HELP system automatically generates therapeutic instructions regarding ventilator management to healthcare providers based on data input by the laboratory and by physicians, nurses, and respiratory therapists. The system has been used successfully to manage complex patient trials with great success (Henderson et al., 1991, Morris 2001, Morris 2003).

In contrast, the **antibiotic-assistant program** developed by Evans and colleagues (1998) (also at LDS Hospital) acquires data from the rich coded database of the HELP system and provides “consultation” to physicians ordering antibiotics for patients who have or who are suspected of having an infection. The program is designed to fit into the work flow pattern of practitioners. It provides physicians with the latest pertinent information about individual patients. The computer provides decision support to suggest the appropriate antibiotic for the patient or even to indicate the lack of a need for such a medication. The program uses the patient’s admission diagnosis, white-blood cell count, temperature, surgical-procedure data, chest radiograph interpretation (free text), and information from the pathology and microbiology laboratories to make its recommendations. The knowledge base used to drive the clinical recommendations was created from analysis of historical “antibiograms” and the knowledge of clinical and infectious disease experts. Physicians have been enthusiastic users of the system because it provides the relevant data in about 5 seconds, whereas it may take 15 minutes or more to acquire the same data from patient records. In addition, the system was shown to improve the quality of patient care and reduce costs (Evans et al., 1998).

### ***17.5.8 Demonstrating the Efficacy of Care in the Intensive-Care Unit***

Intensive-care-unit care is expensive. Given the current pressures to control healthcare spending (see Chapter 23), there is growing concern about the cost effectiveness of such care. In a 1984 study prepared for the Office of Technology Assessment, one researcher

estimated that 15 to 20 percent of the nation's hospital budget, or almost 1 percent of the gross national product, was spent for ICU care (Berenson, 1984). Unfortunately, the problems of assessing the benefit of each element in the ICU are many; to date, no definitive studies have been performed. It is difficult to identify and isolate all the factors in the ICU setting that affect patient recovery and outcome. To this end, a Coalition of Critical Care Excellence of the Society of Critical Care Medicine recently reviewed the issues related to developing evidence about the safety and effectiveness of critical care monitoring devices and related interventions (Bone, 1995). Furthermore, the ethical implications of withholding potentially beneficial care from patients in the control group of a randomized clinical trial make such studies almost impossible to perform. As discussed in Section 17.4.3 and 17.5.7, a computer-assisted program for management of antibiotics at LDS Hospital was found to improve the quality of patient care while reducing associated costs (Evans et al., 1998). Recently work by Clemmer and colleagues has shown important improvements in quality of care and outcomes using collaborative methods supported by computer technology. (Clemmer 1999). Also, work by Adhikari and Lapinsky gives an outline of technology assessment techniques (Adhikari 2003). Further, several intensivists have projected the current and future value of critical care computing (Seiver 2000, Seiver 2003, McIntosh 2002, Varon 2002).

At Cedar-Sinai Medical Center, physiological data, ICU utilization data, and measurable outcomes for specific subsets of ICU patients have been analyzed to determine which patients require care or observation that can only be performed in an ICU. Using these results, the medical center has developed guidelines and pathways for use of the ICU by similar patients. These guidelines have been approved by the various divisions of surgery. Intensive-care unit pathways, including guidelines for nonadmission to the ICU in some cases, are in place for elective craniotomy, thoracotomy, carotid endarterectomy, infrainguinal arterial surgery, ovarian cancer surgery, kidney transplantation, and liver transplantation. Use of these pathways and guidelines has reduced the average ICU cost of caring for these groups of patients, with no adverse changes in outcome (Amir et al., 1997; Chandra et al., 1995; Cunneen et al., 1998; McGrath et al., 1996; Shabot, 1997a). Figure 17.27 shows part of the pathway for infrainguinal arterial surgery, and Figure 17.28 shows the pop-up guideline for ICU admission for these patients.

### ***17.5.9 Responsible Use of Medical Software***

Use of medical software has become ubiquitous, especially in the ICU. There is a growing literature documenting how computerized systems improve health-care delivery (Garibaldi, 1998). There are also concerns, however, about patient safety that must still be addressed. The Food and Drug Administration (FDA) has called for discussions about further regulating of such software (Miller & Gardner, 1997a). The American Medical Informatics Association and others have made recommendations about how such software should be monitored and evaluated (Miller & Gardner, 1997b). See Chapter 10 for a discussion of legal issues in healthcare informatics and Chapter 11 for a detailed discussion of software evaluation.

Clinical Pathways		8SICU 1 8246		1.83m2 150.01b	
Actions		Print	Store...	S/O Data...	HELP
Pathway		Apr 01 96	Apr 02 96	Apr 03 96	
1	1 INFRINGUINAL BYPASS GRAFT	Pathway Day 1	Pathway Day 2	Pathway Day 3 (Floor Care)	
2	2 LEVEL OF CARE (B1)	1. Operating Room	1. SICU		
3		2. Recovery Room	2. Floor Care		
4		3. G2 - GUIDELINE FOR TRANSFER TO ICU VS. FLOOR CARE			
5	3 DIAGNOSTIC TESTS/PROCS (B1)		CBC + Chem I		
6			PT		
7			PTT		
8	4 MEDICATIONS (B1)	Ancef q8h	Ancef q8h		
9		Heparin Drip	Heparin Drip		
10		Pain Management (PCA)	Pain Management (PCA)		
11	5 TREATMENTS (B1)	Intravenous line	D/C IV		
12		O2 PRN	D/C O2		
13		Pulse Oximeter	D/C Pulse Oximeter		
14	6 ACTIVITY (B1)	Bedrest	OOB to chair		
15		Leg elevated	PT eval		
16	7 NUTRITION (B1)	NPO	1. Start Clears		

ABG Results at 1815 Apr 01 96 Available Mon Apr 01 96 1849

**Figure 17.27.** Cedars-Sinai Medical Center pathway for managing infrainguinal bypass graft patient. Note the embedded guideline for ICU versus floor care after the Recovery Room (Pathway Day 1). (Source: Courtesy of Cedars-Sinai Medical Center.)

Clinical Pathways		8SICU 1 8246		1.83m2 150.01b	
Actions		Print	Store...	S/O Data...	HELP
Pathway		2. LEVEL OF CARE (B1)			
1		0. GUIDELINE G2 - POST-OPERATIVE DISPOSITION (ICU VS. FLOOR)			
2		1. Absolute indications for admission to ICU			
3		1a. Pt intubated			
4		1b. IV vasoactive or antiarrhythmic meds required after PPOH (Recovery Room)			
5		1c. Pulmonary artery catheter required after PPOH (Recovery Room)			
6		2. Relative indications for admission to ICU			
7		2a. Reoperation for complications on the day of surgery			
8		2b. Age > 80 and pre-op length of stay > 3 days			
9		2c. Operating time > 4 hours			
10		2d. Blood loss requiring > 2 units PRBC transfusion			

ABG Results at 1815 Apr 01 96 Available Mon Apr 01 96 1848

**Figure 17.28.** Pop-up guideline for admission to ICU versus floor care after infrainguinal bypass graft. The evidence-based criteria were derived from the actual ICU courses of hundreds of patients undergoing this operation at Cedars-Sinai Medical Center. (Source: Courtesy of Cedars-Sinai Medical Center.)

### ***17.5.10 Integration of Bioinformatics and Genomics with Critical Care***

Critically ill patients are monitored extensively and intensively with methods discussed in this Chapter. However, up to now the goal of monitoring has been to measure the degree of injury and to prevent further injury, rather than to measure “repair.” In the future we may be able to monitor the progress of “repair” by using genomic and proteomic markers (Hopf 2003). These types of monitors would enable clinicians to control the healing environment using these biomarkers. For example, diagnosis of infection in the critically ill patient requires that cultures of pathogens be made. Culturing and subsequent determination of the sensitivity of an appropriate antibiotic can take days. With the ability to detect bacterial DNA we should be able to detect and identify the active bacteria using genetic markers. These new techniques will require the use of computerized patient records and tools developed by our Bioinformatics colleagues.

### ***17.5.11 Consensus Conference on Critical-Care Medicine***

A global perspective on what should be done to improve critical-care patient-data management can be gained from a 1983 consensus conference organized by the National Institutes of Health (Ayers, 1983). Although formulated in the mid-1980s, the conclusions of this conference concerning areas of improvement in treatment of critically ill patients remain pertinent today. Many of these problems are amenable to computer assistance. Technical difficulties, errors in data interpretation, and increasing interventions caused by continuous monitoring are potential nosocomial hazards for ICU patients. Based on the findings of the original conference, we identify eight areas in which computers can assist in the practice of critical-care medicine.

1. All ICUs should be capable of arrhythmia monitoring. Bedside physiological monitors with microcomputers now provide excellent arrhythmia monitoring.
2. Invasive monitoring should be performed safely. Computer-based charting of invasive events such as the insertion of an arterial catheter, analyzed in combination with data from the microbiology laboratory, can help to avoid infection (a major complication of invasive monitoring).
3. Generated data should be correct. The computer can check data as they are entered to verify that they are reasonable. In addition, data communications and calculation errors can be reduced or eliminated by letting the computer do the work.
4. Derived data should be interpreted properly. The computer can assist in the integration of data from multiple sources. In addition, the computer can derive parameters and also can provide prompt, accurate, and consistent interpretations and alerts.
5. Therapy should be employed safely. The computer can assist physicians by suggesting therapy, calculating appropriate drug doses, and flagging combinations of interacting drugs.
6. Access to laboratory data should be rapid and comprehensive. Computer networking provides quick access to all laboratory data and can even interpret the results and provide alerts.

7. Enteral (tube-feeding) and parenteral (IV) nutritional-support services should be available. There are interactive computer programs that help physicians to prescribe care by assisting with the complex task of determining the appropriate volume and content of nutritional supplements.
8. Titrated<sup>6</sup> therapeutic interventions with infusion pumps should be available. In theory, closed-loop systems for controlling the administration of fluids and intravenous drugs could facilitate patient care. In reality, however, work to date in this area has proved unsuccessful.

The availability of microcomputers has greatly enhanced the ability to generate and process the physiological data used in patient monitoring. The use of computers in the ICU is still an area of growth, however. Although advances in signal processing and ICU information systems have been significant, many challenges remain in the exploration of ways with which the computer can be used effectively to integrate, display results, evaluate, and simplify the complex data used in caring for critically ill patients.

## Suggested Readings

Gardner R.M., Sittig D.F., Clemmer T.P. (1995). Computers in the intensive care unit: a match meant to be! In W.C. Shoemaker et al. (Eds.), *Textbook of Critical Care* (3rd ed., pp. 1757–1770). Philadelphia: W.B. Saunders.

This chapter summarizes the current status of medical practice in the ICU. Other chapters in the handbook will be of interest to the medical computer scientist who is exploring the use of computers in critical-care settings.

Ginzton L.E., Laks M.M. (1984). Computer aided ECG interpretation. *M.D. Computing*, 1:36. This article summarizes the development of computer-based ECG interpretation systems, discusses the advantages and disadvantages of such systems, and describes the process by which a typical system obtains and processes ECG data.

Strong D.M., Lee Y.W., Wang R.T. (1997). 10 potholes in the road to information quality. *IEEE Computer*, 31:38–46.

This article provides an entertaining and thoughtful presentation of the problems we all face as we acquire data. Its use of a general strategy to discuss data-quality problems and relate them to the medical field is refreshing.

Morris AH. Rational use of computerized protocols in the intensive care unit. *Crit Care* 2001 Oct;5(5):249-254.

Excess information in complex ICU environments exceeds human decision-making limits. This article outlines the strategies needed to use computerized protocols in a busy clinical critical care unit. The author bases his recommendations on decades of experience.

---

<sup>6</sup>Determination of the concentration of a dissolved substance. Titration is a method for adjusting the concentration of a drug to achieve a desired effect—for example, adjusting nitroprusside infusion to control blood pressure.



## Questions for Discussion

1. Describe how the integration of information from multiple bedside monitors, the pharmacy, and the clinical laboratory can help to improve the sensitivity and specificity of the alarm systems used in the ICU.
2. What factors must you consider when deciding when and how often a physiological, biochemical, or observational variable should be measured and stored in a computer's database?
3. You have been asked to design part of an electronic exercise bicycle. Sensors in the hand grips of the bicycle will be used to pick up transmitted electrical signals reflecting the rider's heart activity. Your system then will display the rider's heart rate numerically in a liquid crystal display (LCD).
  - a. Describe the steps your system must take in converting the heart's electrical signals (essentially a single ECG lead) into the heart rate displayed on the LCD.
  - b. Describe how computerized data acquisition can be more efficient and accurate than manual methods of data acquisition.